

2024

Featured Products Guide

Motors • Components • Service & Installation



MARS Bulk Packaged Whips
see page 7



PolarPad
see pages 4-5



Azure® ECM
see pages 22-27



Filter Driers
see page 57

The Leading Brands You Trust For...

- Quality
- Innovation
- Design
- Leadership

MARS has been serving the HVAC/R market since 1946 and is proud to present the most complete motor, component and accessory product offering to serve your needs. Our capabilities include:

- Consolidation - One Stop Shop
- Over 14,000 combinable products
- Industry leading brands
- Innovative products
- Award winning distribution facilities
- High order fill rate
- Shipments within 24 hours
- Billing accuracy
- Sales coverage serving every customer location
- In-house Art Department for customer flexibility
- Bilingual Website
- On-line training – www.marsuniversity.com
- EDI capabilities

Thank you for your business!

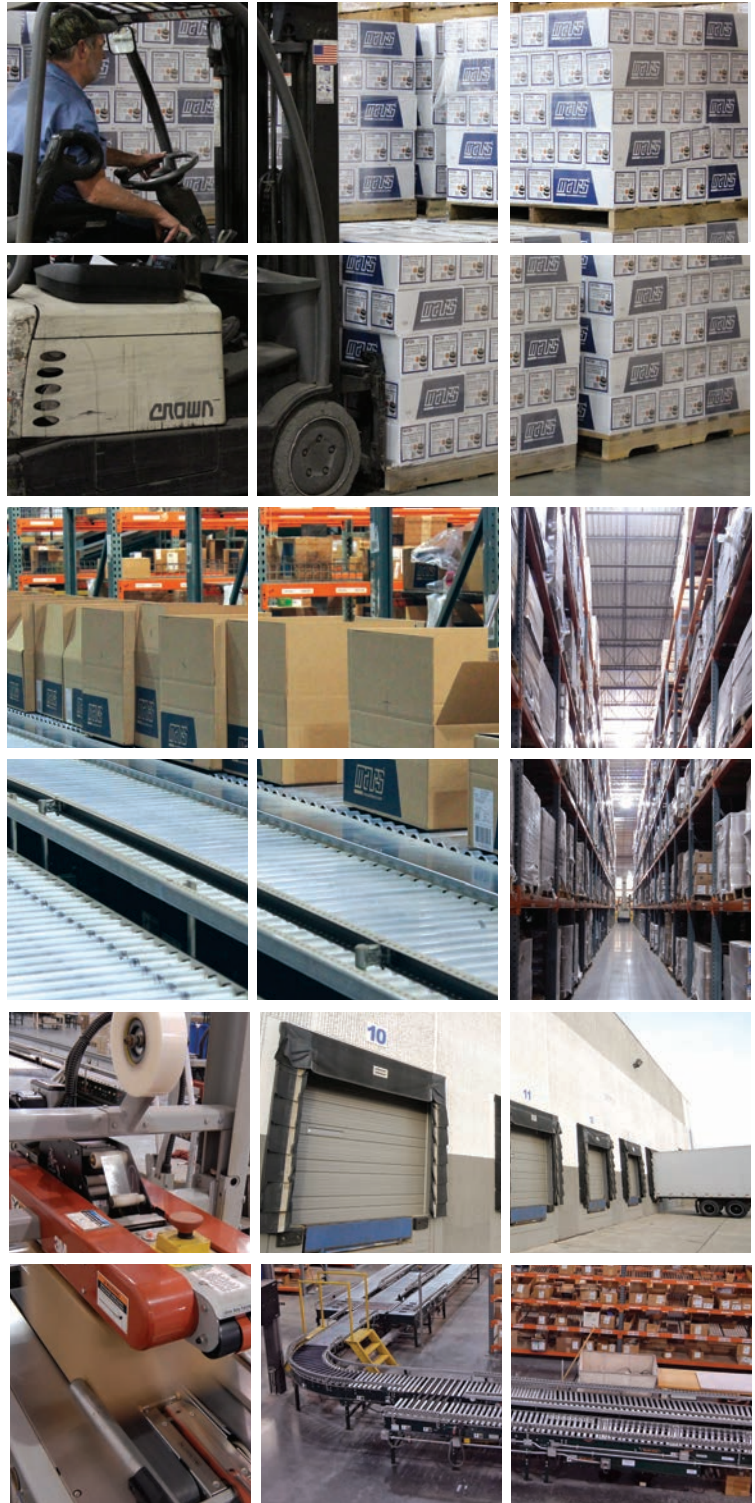

©2023 MOTORS & ARMATURES, Inc.

All rights reserved. This catalog may not be reproduced in whole or in part in any form without written permission from Motors & Armatures, Inc. MARS is a registered trademark of Motors & Armatures, Inc. MARS part numbers are trademarks of Motors & Armatures, Inc.

Table Of Contents

Service & Installation	Page No.
A/C Condenser Pads.....	4-6
A/C Mounting Brackets.....	6
A/C Whips.....	7
Air Purifier, Whole Home.....	11
Anti-Vibration Pads.....	13
Capacitors, Mini-Split.....	17
Compressor Terminal Repair Kit.....	21
Concentric and Horizontal Vents, MARS.....	18
Cool Gel.....	14
Cork & Foam Tape, MARS.....	20
Disconnects, MARS.....	8,9, 10
Disconnects, Midwest.....	10
Disconnect Switch, Mini-Split.....	17
Duct Straps.....	13
Energizer Industrial Alkaline.....	21
Fireblock Foam Sealant.....	18
Flux Paste.....	14
Foam Sealing Products.....	18
Furnace Legs, Adjustable.....	12
Furnace Mounting Blocks.....	12
Fuses, JARD.....	15
Gloves.....	20
Heat Pump Risers.....	12
Heat-Seal Stik®.....	14
Line Set Connectors.....	17
Markers, Dura-Ink®.....	14
MARS Bulk Packaged Whips.....	7
Mini-Split Wall Mount Brackets.....	6
Mounting Brackets.....	6
PolarPad.....	4-5
Putty, MARS.....	18
Remote Control, MARS.....	17
Roof Support Systems.....	20
Silicone Sealants.....	18
Slic-Tite® Paste.....	14
Stainless Steel Vibration Absorbers.....	21
Tarps.....	18
Thermostat Guards.....	19
Tubing, Clear Vinyl.....	13
Tubing, PVC Braided.....	13
V-Belts, Gates.....	16

Motors	Page No.
3.3" Commercial Refrigeration Motors.....	26, 35, 42
Azure® ECM.....	22-27
Azure® Refrigeration Motors.....	26, 27
Azure® Watt Motors.....	26, 27
Belted Fan & Blower Motors.....	33
Commercial Fan & Blower.....	41
Commercial Refrigeration Fan Motors.....	27, 35, 42
Condenser Fan Motors.....	28-31, 36, 37, 40
Direct Drive Blower Motors.....	32, 33, 34, 38
Draft Inducer Motors.....	42
Fan Coil A/C & Heating Unit Motors.....	42
Motors, FASCO.....	42
Motors, Genteq.....	43
Motors, JARD.....	36-38, 39
Motors, Marathon.....	40-41
Torsion Flex Mount Motors.....	32
Watt Motor, MARS & JARD.....	39

MARS Components	Page No.
Capacitors, USA.....	48
Capacitors, Turbo & Hardstarts.....	49
Check Valve Replacement.....	54
Condensate Overflow Switches, MARS.....	55
Condensate Pumps.....	54
Contactors, MARS 780.....	44-45
Contactors, MARS 910 Definite Purpose.....	46
Contactors, JARD.....	47
Corrugated Condensate Drain Line, MARS.....	54
Disconnect with Internal Surge.....	51
Fan Blades and Accessories.....	65
Fan Control Centers.....	50
Filter Driers, JARD.....	57
Flame Sensors.....	63
Hard Start Kits, MARS.....	56
Hot Surface Igniters.....	62
HVAC Surge Protective Devices, MARS.....	51-53
Mini-Split Condensate Pump.....	55
Pressure Switches, JARD.....	60
Pressure Switches, MARS.....	61
Restricting Kit.....	59
Switching Relays, JARD.....	50
Thermocouples.....	59
Transformers, MARS.....	64
Transformers, JARD.....	64
Universal TXV Kit.....	58



PolarPad™

HEAVY DUTY HVAC PADS



RUGGED, RELIABLE & IMPACT RESISTANT...

Start Strong with PolarPad

Condenser installations begin better with PolarPad. The PolarPad is a plastic pad engineered and designed as a base for HVAC equipment. The pad is injection molded from polyethylene, which is durable, strong, and lightweight. The unique design has strong, uniform ribbing along the underside. The pad is molded with a texture along the top for traction, and rounded edges on the sides to give a clean concrete look and feel.

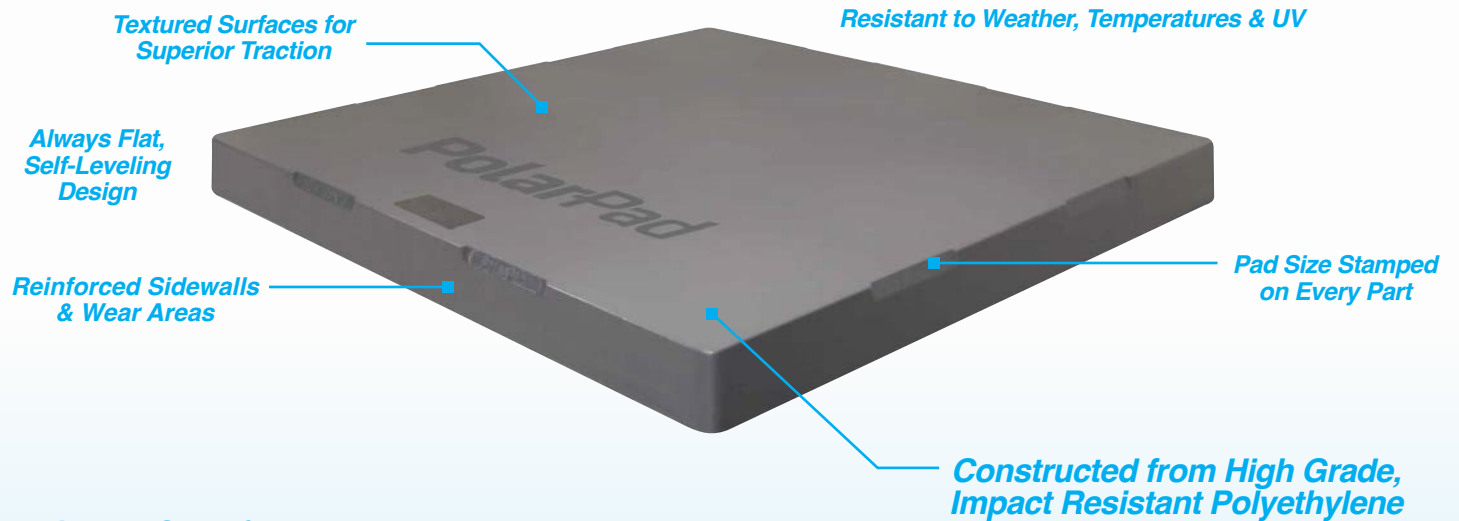

Technical Specifications

- ❑ **Polyethylene Resin Resistance:**
 - refrigerants, oils, salt solutions, canine urine, and UV degradation
- ❑ **Service Temperature:**
 - -60°F to 180°F
- ❑ **Combustible Temperature:**
 - 662°F auto ignition
 - 649°F flash ignition
- ❑ **Polyethylene Resin Approvals:**
 - ASTM D4976 – PE233
 - FDA 21 CFR 177.1520[®] 3.2a (B-H per 21 CFR 176.170(c))

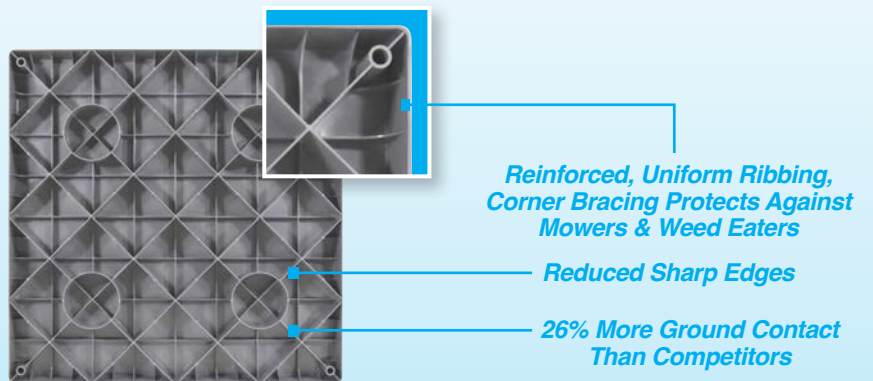

Unparalleled Durability, Perfectly Level, and 90% Lighter Than Concrete Pads... and That's Just the Tip of the Iceberg.





A LOT BELOW THE SURFACE...

Start Strong with PolarPad

The PolarPad Difference			
Superior Strength	✓	Self-Leveling	✓
Lightweight	✓	Resists Cracking	✓
UV Resistance	✓	Virgin Material	✓
Superior in Cold Weather	✓	Made with Polyethylene	✓
Superior Impact Resistance	✓	Always a Flat Part	✓
Reinforced Sidewalls	✓	Consistent Availability, Lead Times	✓
Superior Lifespan	✓	Consistent Coloring	✓

Multiple Sizes, Profiles

MARS No.	Model	Size: W x L x H (in)	Color	Pallet Quantity
94765	POLAR3030-2	30 x 30 x 2	Gray	23
94762	POLAR3232-2	32 x 32 x 2	Gray	23
94773	POLAR3636-2	36 x 36 x 2	Gray	23
94740	POLAR1838-3	18 x 38 x 3	Gray	32
94777	POLAR2424-3	24 x 24 x 3	Gray	64
94778*	POLAR2436-3	24 x 36 x 3	Gray	32
94729	POLAR2448-3	24 x 48 x 3	Gray	32
94784	POLAR3030-3	30 x 30 x 3	Gray	16
94787	POLAR3232-3	32 x 32 x 3	Gray	16
94792	POLAR3636-3	36 x 36 x 3	Gray	16
94791	POLAR3842-3	38 x 42 x 3	Gray	16
94795	POLAR4040-3	40 x 40 x 3	Gray	16

*Early 2024 Availability



Toll Free (800) 445-4155 • Fax (631) 348-7160
www.marsdelivers.com



MARS A/C Condenser Pads

Features & Benefits:

- UV stable – prevents weathering or cracking
- Chemical resistant
- Solid wall construction
- Will not chip or crack
- Lightweight
- Textured surface – prevents unit from sliding
- Unique footpads – prevent unit from sinking into ground

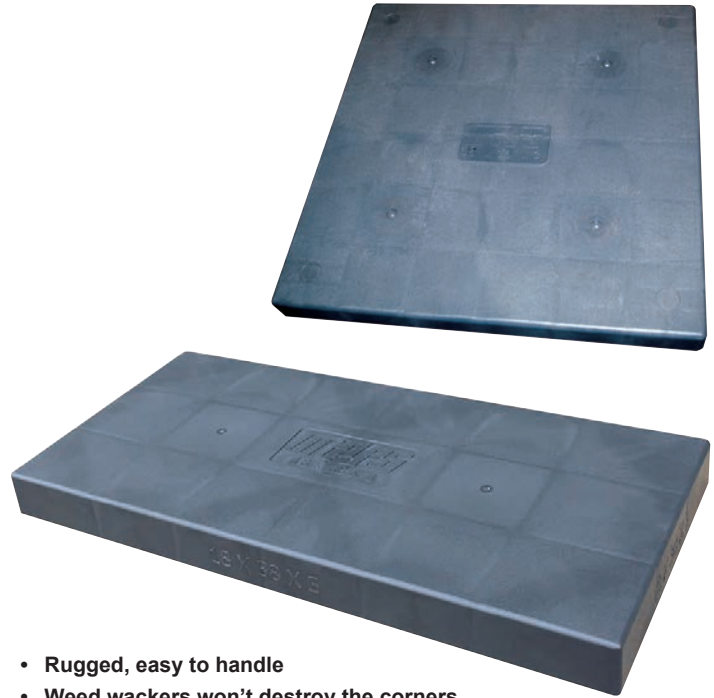

- Rugged, easy to handle
- Weed wackers won't destroy the corners
- Two and three inch thick pads are available

MARS NO.	DESCRIPTION	PALLET QTY.
93560	24" x 24" x 2"	22
93561	24" x 36" x 2"	22
93576	36" x 40" x 2"	22
93593	36" x 40" x 3"	16
93594	36" x 48" x 3"	16

MARS Universal Mini-Split Condenser Wall Mount Brackets

MARS mini-split brackets are available in four sizes to accommodate mounting of popular mini-split compressors.

Bracket kits include mounting hardware and vibration absorbers for a professional installation. Pre-assembled vertical supports speed installation.

- Powder Coat Finish - resists rust and corrosion
- Mounting and attachment hardware included
- Bracket width and depth adjust to accommodate compressor size
- Vibration pads included for a durable and quiet installation
- Pre-assembled vertical supports reduce installation time

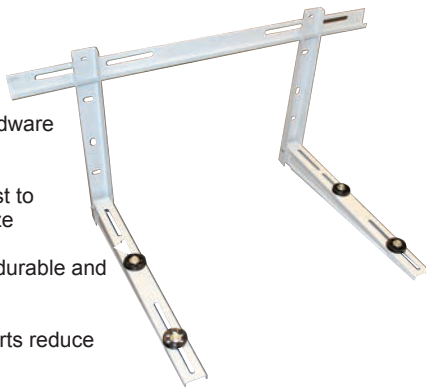

****Order in multiples of 4****

MARS NO.	SIZE	LOAD CAPACITY (LBS)
93640	14.5" x 18" x 33.5"	260
93641	18" x 22" x 33.5"	330
93642	18" x 24" x 33.5"	400

A/C Mounting Brackets

Heavy duty engineered steel A/C brackets are used for mounting A/C condensers and heat pumps on vertical walls. Brackets include mounting holes and are finished in a durable gray powder coat.



MARS NO.	DESCRIPTION	MARS PACK
93630	30" Powder Coated Steel Bracket	1 Pair
93631	36" Powder Coated Steel Bracket	1 Pair
93632	42" Powder Coated Steel Bracket	1 Pair
93636	48" Powder Coated Steel Bracket	1 Pair

MARS Bulk Packaged A/C Whips, Non-Metallic Fittings

Non-metallic conduit with non-metallic fittings. These are individually packaged. Assembled with UL approved components.

- Packaged gaylord style
- Bulk box for easy access



MARS NO.	DESCRIPTION	MARS PACK
84181	4' x 1/2" #10 ga. non-metallic whip UL	90
84183	4' x 3/4" #8 ga. non-metallic whip UL	60
84185	6' x 1/2" #10 ga. non-metallic whip UL	60
84187	6' x 3/4" #8 ga. non-metallic whip UL	45

MARS A/C Whips

- Assembly UL listed.
- Extra long wire for easy hook up
- Bagged individually

Non-Metallic Fittings

Non-metallic conduit with non-metallic fittings.

MARS NO.	DESCRIPTION	MARS PACK
84131	4' x 1/2" #10 ga. non-metallic whip UL	1
84133	4' x 3/4" #8 ga. non-metallic whip UL	1
84135	6' x 1/2" #10 ga. non-metallic whip UL	1
84137	6' x 3/4" #8 ga. non-metallic whip UL	1
84139	8' x 1/2" #10 ga. non-metallic whip	1
84141	8' x 3/4" #8 ga. non-metallic whip	1
84143	10' x 3/4" #8 ga. non-metallic whip	1

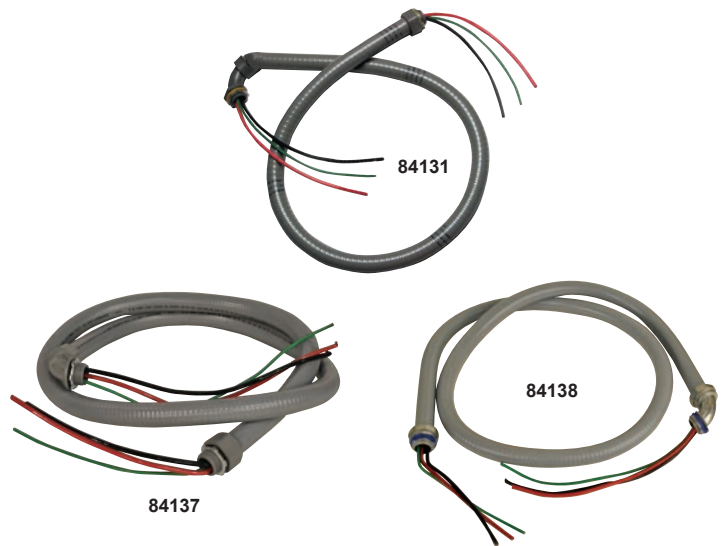

Whips Metallic Fittings

Non-metallic conduit with metallic fittings.

MARS NO.	DESCRIPTION	MARS PACK
84132	4' x 1/2" #10 ga. metallic whip UL	1
84134	4' x 3/4" #8 ga. metallic whip UL	1
84136	6' x 1/2" #10 ga. metallic whip UL	1
84138	6' x 3/4" #8 ga. metallic whip UL	1

Whips All Metallic

MARS NO.	DESCRIPTION	MARS PACK
84125	4' x 1/2" #10 ga. all metallic whip	1
84126	4' x 3/4" #8 ga. all metallic whip	1
84127	6' x 1/2" #10 ga. all metallic whip	1
84128	6' x 3/4" #8 ga. all metallic whip	1

Got A Surge Protector? Get This!

New Side Open 60A Non-Fused Disconnect With UL Listed Lugs For Use With Surge Protective Devices

MARS Low Profile 60A Non-Fused Disconnect

MARS side open low profile disconnect box is compact while providing easy access to the connection points. The finger safe pullout section prevents accidental contact with the live circuit. The lugs are rated for multi-conductors and are approved for use with surge protection devices.

Specifications:

- Single phase, 120/240V
- Dimensions: 6.625" x 5" x 2.50"
- Tin plated copper pullout
- Lugs rated for multi-conductors
- 10,000 Amp max. rated
- NEMA 3R, rainproof
- cULus rated



Surge protector is not included

80301 AC DISCONNECT
60A SCCR

WIRE RANGE DATA
LUG TIGHTENING TORQUE (LB-IN)

SCREW TYPE	WIRE SIZE	TORQUE
SLOTTED	14-10	35
	8-6, (2)10	40
	(1)10 and (1)8	45

COPPER WIRE RANGE DATA

CONNECTOR	AWG STR
LINE/LOAD	14-6
EQUIP. GRD	12-4, (2)10

3R RAINPROOF ENCLOSURE

80301

MARS No.	DESCRIPTION	STD. PACK	Case Qty
80301	60 amp non-fused	10	10

Top Open A/C Disconnects, NEMA 3R

MARS offers both fusible and non-fusible single phase air conditioner disconnects. These units provide a disconnecting means which should be located within sight and readily accessible from the air conditioning or refrigerating equipment.

- Single phase
- 120/240 Volts
- Fused Disconnects - accepts type H fuse (not included)
- 10kAIC
- Enclosure material: galvanized steel
- NEMA 3R, rainproof, outdoor use
- Dimensions: 9.21" H x 5.45" W x 3.13" D



MARS NO.	DESCRIPTION	STD. PACK	CASE QTY.
83615	60 Amp, Non-Fused	6	6
83616	30 Amp, Fused	6	6
83617	60 Amp, Fused	6	6

MARS Disconnect Boxes

Side Open Pullout



MARS NO.	DESCRIPTION	STD. PACK	CASE QTY
80315	60 amp non-fused	6	6
80316	30 amp fused	6	6
80317	60 amp fused	6	6

Front Open Pullout



- Market leader
- High quality box
- UL & CUL
- NEMA 3R, rainproof
- Single phase
- Pullout type

MARS NO.	DESCRIPTION	MARS PACK
83315	60 amp non fused	6
83316	30 amp fused	6
83317	60 amp fused	6
83396	Compact 30 amp fused	6



MARS No. 83335
Description:
 Generic brand 60 amp non-fused
MARS Pk: 6

MARS Side Open Pullout Disconnect w/GFCI Receptacle

Specifications:

- 60 amp, non-fused, pullout type
- Pre-wired 15A, 125V GFCI receptacle included
- 240 volt, 1P
- 10,000 amp rated
- NEMA 3R & UL rainproof
- UL & CUL approved
- Rated for 10HP @ 240 volts
- Meets NEC #210.63 & #406.8(B)(1)
- Multiple patents pending

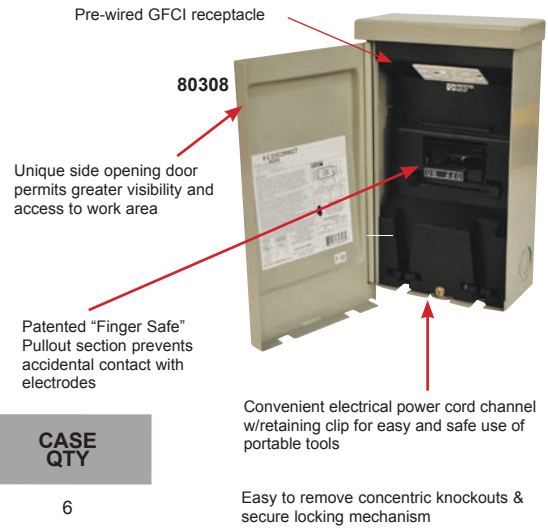

MARS NO	DESCRIPTION	STD. PACK	CASE QTY
80308	Pullout disconnect, W/GFCI receptacle	6	6

MARS A/C Disconnect/GFCI Receptacle Combination

MARS NO.	DESCRIPTION	MARS PACK
83308	60 Amp, Non-Fused, 15 Amp, 125V GFCI Duplex Receptacle	6
83309	60 Amp, Non-Fused, 20 Amp, 125V GFCI Duplex Receptacle	6



Midwest Three Phase Pullout Disconnects - 240V - NEMA 3R



Midwest Electric three phase pull out disconnects and single phase non-automatic switches are manufactured of heavy zinc coated steel with highest quality electro-deposition paint finish for maximum corrosion resistance. The three phase disconnects are available with and without fuse protection. Fusible units require three fuses. NEMA 3R.



83321

MARS NO.	DESCRIPTION	CASE QTY.
83321	60 amp non-fused, three phase	4
83322	30 amp fused, three phase	4
83323	60 amp fused, three phase	4

Midwest Heat Pump Disconnects - NEMA 3R



Multiple disconnect devices are offered for heat pump applications that require individual disconnects for the heating and cooling cycles. The dual pull outs accommodate either a 30A/60A or 60A/60A puller combination. Units require four fuses.

Specifications:

- 120/240 AC



83324

MARS NO.	DESCRIPTION	CASE QTY.
83324	90 amp fused	1
83325	100 amp fused	1

Whole Home In-Duct Air Purification System

Made in USA With Globally Sourced Components



Clean Purified Air To All Rooms

MARS No. 00700

The Comfort-Aire® in-duct air purification system is the industry's first photocatalytic air purifier to use LED technology.

REDUCES

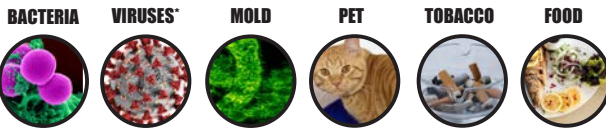

* Including MS2 (a widely accepted test surrogate for SARS-CoV-2; the virus that causes Covid-19)

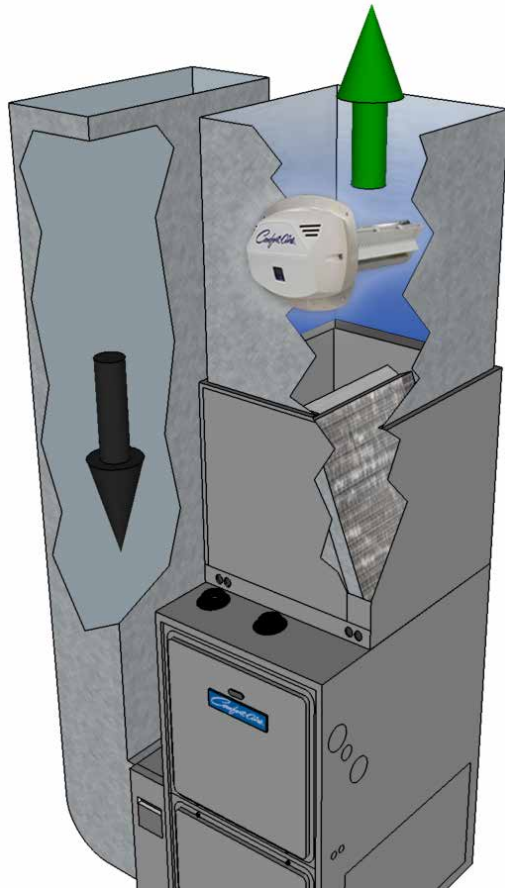

Reduces 99.9% of Airborne Microbials*

Think your furnace filter cleans your air? Typical furnace filters capture only dust and other large airborne particles. Unhealthy microbes can easily pass right through and continually circulate throughout your home.

Comfort-Aire's hybrid photocatalytic oxidation process uses a traditional UV-C lamp and an array of long-life UV-C LEDs to react with two separate catalysts. This dual action creates a powerful field of oxidative elements. As air passes through the field the pollutants are oxidized and reduced resulting in cleaner air.

FEATURES

- Silent Operation
- Energy Efficient (32W)
- Virtually Maintenance Free
- Nothing To Set or Adjust
- Long Life LED Technology
- Zero Ozone
- 7 Year Limited Warranty (3 Years On Lamp)



State of California required warning



WARNING: This product produces UV light that utilizes mercury for its operation. If the lamp is broken, this product could expose you to mercury, which is known to the State of California to cause cancer and birth defects or other reproductive harm. For more information to www.P65Warning.ca.gov

Clean Air is Life

LET US HELP PROTECT YOURS

MARS Economy Furnace Mounting Blocks

- Holds furnace 2" off the floor
- Absorbs vibration, reduces noise
- Composite construction
- Peel & stick installation

MARS NO.	DESCRIPTION	MARS PACK
79085	Economy Furnace Mounting Blocks	12



MARS Heat Pump Risers

Heavy duty composite heat pump risers are available in 2 popular heights in a cost effective 1 piece design as well as a 2 piece terrain adaptable design.

Each riser includes factory installed built mastic patches on the top and bottom to absorb vibration and reduce noise.

MARS NO.	DESCRIPTION	MARS PACK
93600	3" 1 Piece Heat Pump Riser	48
93601	6" 1 Piece Heat Pump Riser	24
93602	3" 2 Piece Heat Pump Riser	32
93603	6" 2 Piece Heat Pump Riser	16
93604	4" Riser Extension	16
93639	Adjustable 5-3/4" to 7" Heat Pump Riser	



93600



93604

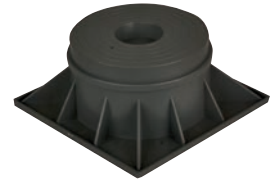

93602



93601



93639



93603

MARS Easy Leveler™ Adjustable Furnace Legs

- Includes 4 easy leveler legs & sheet metal screws
- Designed to level a furnace & air conditioning coil for proper drainage
- Proper leveling helps eliminate standing water, thus reducing bacteria
- Easily adjustable even after installation
- Legs can support up to 400 lbs.
- Adjustable from 2-3/4" to 4" height

79095



Anti-Vibration Pads

MARS offers a complete line of anti-vibration pads. These high quality rubber pads provide maximum loading of 60 lbs. per square inch. Anti-vibration pads can be used on any type of mechanical/ electrical machines such as pumps, motors, air conditioning units, generators, compressors, etc. The plain rubber pads have grooves on both sides. The cork rubber pads are the same but with the added advantage of reduction in sound level. The natural rubber Iso-Pads can be easily cut for odd sized dimensions under equipment legs and supports. The use of these pads eliminates the need for bolting down equipment to the floor. These Iso-Pads provide superior isolation, attenuation and vibration characteristics.

MARS NO.	DESCRIPTION	MARS PACK
52101	2" x 2" x 3/8" Rubber	1
52103	4" x 4" x 3/8" Rubber	1
52104	6" x 6" x 3/8" Rubber	1
52107	18" x 18" x 3/8" Rubber	1
52108	2" x 2" x 7/8" Cork/Rubber	1
52109	3" x 3" x 7/8" Cork/Rubber	1
52110	4" X 4" X 7/8" Cork/Rubber	1
52111	6" x 6" x 7/8" Cork/Rubber	1
52114	18" x 18" x 7/8" Cork/Rubber	1
52115	2" x 2" x 3/4" Iso-Pad	1
52116	4" x 4" x 3/4" Iso-Pad	1
52117	18" x 18" x 3/4" Iso-Pad	1
52119	2" x 2" x 7/8" Foam/Rubber	1
52118	4" x 4" x 7/8" Foam/Rubber	1
52120	6" x 6" x 7/8" Foam/Rubber	1
52122	18"x18"x7/8" Foam/Rubber	1

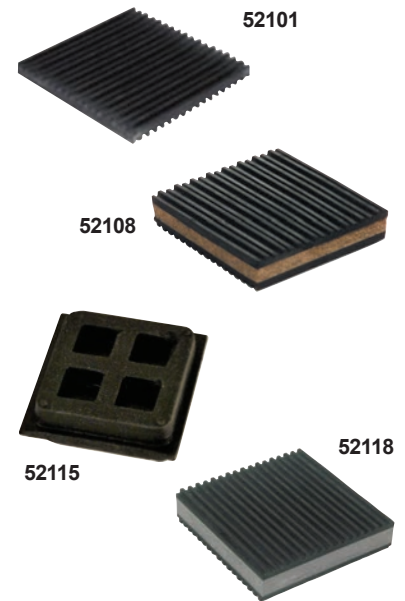

Polypropylene Web Duct Strap

- Designed for the hanging of flexible ducting
- Made of high tensile strength - 400 lbs. min. up to 460 lbs. max.
- Abrasion & chemical resistant
- Easy to cut & staple to joists
- UL 723 Flame and Smoke



MARS NO.	DESCRIPTION	MARS PACK
86126	Black 1-3/4" x 100 yds.	24
86296	Black 3" x 100 yds	8
86297	Silver 1-3/4" x 100 yds	24
86298	Silver 3" x 100 yds	8

MARS Duct Straps

- Versatile & suitable for a variety of applications
- Bent tip design is easy to pick up from flat surfaces and allows faster initial threading to speed installation
- Finely spaced gear rack allowing for exact adjustment ensuring a snug fit



MARS NO.	DESCRIPTION	MARS PACK
86128	36" Duct Strap, 175 lbs Up to 10" Duct, Natural	50

MARS Clear Vinyl Tubing



MARS NO.	DESCRIPTION	CASE QTY
79131	1/4" ID clear tubing 32 PSI - .375 O.D.	100'
79132	3/8" ID clear tubing 27 PSI - .500 O.D.	100'
79133	1/2" ID clear tubing 24 PSI - .625 O.D.	100'
79134	5/8" ID clear tubing 21 PSI - .750 O.D.	100'
79135	3/4" ID clear tubing 19 PSI - .890 O.D.	100'
79136	7/8" ID clear tubing 16 PSI - 1.015 O.D.	50'

MARS Heavy Duty PVC Braided Line Tubing

- 41°F (5°C) to 140°F (60°C)



MARS NO.	DESCRIPTION	WORKING PRESSURE	BURST PRESSURE	CASE QTY.
79045	1/4" ID - .407 OD	120 PSI	360 PSI	50'
79046	3/8" ID - .532 OD	120 PSI	360 PSI	50'
79047	1/2" ID - .673 OD	90 PSI	270 PSI	50'
79048	5/8" ID - .822 OD	90 PSI	270 PSI	50'
79049	3/4" ID - .986 OD	90 PSI	270 PSI	50'

Dura-Ink® Fiber Tip Markers

- Larger ink supply, heavy duty metal barrel
- Water - resistant, fade - resistant
- Chisel tip makes fine lines or broad marks
- Meets Fed. Spec. TT-1- 544
- Use on cardboard, wood, metal, paper, ceramics, glass, etc.
- For identification of equipment



LA-CO®
95500

MARS NO.	DESCRIPTION	MARS PACK	CASE QTY.
95500	Dura-Ink® #25 - Black	12	48
95516	Markal Dura-Ink® #25 Black Marker (2-pk)	1	24
95519	Dura-Ink® #15 - Black	1	36

Heat-Seal Stik®

- Fast repairs completed in 90 seconds
- One part epoxy, no mixing or measuring needed
- Stick melts, seals and cures in one operation
- Use on aluminum, copper and other metals, glass and ceramics
- Ideal for use on high and low side of refrigeration systems
- Sealing temperature : up to 350° F (177° C)
- Pressures: to 600 PSI (41 Bar)
- Made in USA



95430

MARS NO.	DESCRIPTION	MARS PACK	CASE QTY.
95430	3/8 oz. stick, carded	12	12

Regular Flux Paste

- Super detergent action cleans as it solders
- Non-acid, non-toxic, lead free
- Contains no zinc chloride
- Use with all common soft solders including: tin-silver, 96/4, 94/6, 95/5, 50/50, 40/60 and 60/40
- For use on copper, brass, galvanized iron, lead, zinc, tin, silver, nickel, mild steel, terne plate, and malleable iron
- Meets Mil. Spec. Mil-F4995 Type II, Meets ASTM B813
- Water soluble for faster flushing from pipe lines
- Made in USA



95443

MARS NO.	DESCRIPTION	MARS PACK	CASE QTY.
95441	2 oz	48	48
95443	4 oz. w/brushcap	48	48
95444	1 lb	24	24

Cool Gel - Heat Dissipating Spray

- Helps prevent heat damage to components and surrounding materials during soldering, brazing, and welding
- Unique gelled formula sticks to surfaces without dripping or running off
- Clear, non-staining gel leaves no residue, eliminating cleanup
- Safe, non-toxic, harmless to skin and odorless
- Saves time - by eliminating the costly disassembly of valves and other components before soldering, brazing or welding
- Protects the seals and seats in ball, dielectric, and solenoid valves
- Protects painted and finished surfaces from discoloration due to adjacent torch operations
- Protects soldered joints from loosening when soldering adjacent joints
- Made in USA



95536

MARS NO.	DESCRIPTION	MARS PACK	CASE QTY.
95536	1 quart	12	12

Slic-Tite® Paste - Thread Sealants

- Contains more PTFE particles for greater sealing power
- Use on metal, PVC, CPVC, and ABS plastic pipe threads
- For sealing water, air, steam, natural gas, LP gas, refrigerants, ammonia, gasoline, and oil
- Do not use on Oxygen service, use thread seal tape or Oxytite® Paste
- Washes off hands and clothing easily
- Non-toxic, non-drying
- Sealing temperature range: -50° F to 500° F (-46° C to 260° C)
- Working pressures: 3,000 PSI (204 BAR) for Gas, 10,000 PSI (680 BAR) for liquids
- USDA approved for use in federally inspected meat and poultry plants.
- Made in USA



95402

MARS NO.	DESCRIPTION	MARS PACK	CASE QTY.
95401	1/4 pt. w/ brushcap	24	24
95402	1/2 pt. w/ brushcap	24	24



For additional fuses see MARS Component, Service & Installation catalog

RK5 Time Delay Fuse 250V

Replaces: TR, ECNR, FRNR, FLNR

MARS NO.	DESCRIPTION	MARS PACK
81006	.5A - 250V	10
81009	1A - 250V	10
81016	2A - 250V	10
81017	2.5A - 250V	10
81019	3A - 250V	10
81020	3.2A - 250V	10
81021	4A - 250V	10
81024	5A - 250V	10
81025	5.6A - 250V	10
81026	6A - 250V	10
81027	6.25A - 250V	10
81029	7A - 250V	10
81030	8A - 250V	10
81032	10A - 250V	10
81033	12A - 250V	10
81034	15A - 250V	10
81035	17.5A - 250V	10
81036	20A - 250V	10
81037	25A - 250V	10
81038	30A - 250V	10
81039	35A - 250V	10
81040	40A - 250V	10
81041	45A - 250V	10
81042	50A - 250V	10
81043	60A - 250V	10
81044	70A - 250V	5
81045	80A - 250V	5
81046	90A - 250V	5
81047	100A - 250V	5
81048	110A - 250V	1
81049	125A - 250V	1
81050	150A - 250V	1
81051	175A - 250V	1
81052	200A - 250V	1
81053	225A - 250V	1
81054	350A - 250V	1
81056	400A - 250V	1
81055	600A - 250V	1

RK5 Time Delay Fuse 600V

Replaces: TRS, ECSR, FRSR, FLRSR

MARS NO.	DESCRIPTION	MARS PACK
81103	.2A - 600V	10
81106	.5A - 600V	10
81109	1A - 600V	10
81110	1.6A - 600V	10
81111	2A - 600V	10
81112	2.25A - 600V	10
81124	5A - 600V	10
81125	6A - 600V	10
81132	10A - 600V	10
81133	12A - 600V	10
81134	15A - 600V	10
81136	20A - 600V	10
81137	25A - 600V	10
81138	30A - 600V	10
81139	35A - 600V	10
81140	40A - 600V	10
81147	45A - 600V	10
81141	50A - 600V	10
81142	60A - 600V	10
81143	70A - 600V	5
81144	80A - 600V	5
81145	90A - 600V	5
81146	100A - 600V	5
81154	110A - 600V	1
81148	125A - 600V	1
81149	150A - 600V	1
81150	175A - 600V	1
81151	200A - 600V	1
81152	250A - 600V	1
81153	300A - 600V	1



ATC Automotive Blade Type Fuse - Fast Acting UL Fuses

General Purpose Plastic Housing with Zinc Fuse Element

MARS NO.	DESCRIPTION	MARS PACK
82230	3A ATC Auto Blade-Type, Violet 32V DC	5
82231	5A ATC Auto Blade-Type, Tan 32V DC	5





GATES V-Belt Product Offering

Hi-Power® II Belts

Gates Hi-Power II belts are engineered for classical applications. They have concave sidewalls to distribute wear evenly while providing proper belt support for improved service life. Flex-bonded cords and flex-weave covers make them the No. 1 choice for heavy-duty conventional V-belt drives. Hi-Power II belts also resist the effects of oil, heat, ozone, weather and aging while meeting RMA standards for static conductivity.

Truflex® V-Belts

Gates Truflex® belts offer improved performance on light duty, fractional horsepower (FHP) V-belt drives. Their unique construction provides smooth, quiet operation with less vibration.

Features & Benefits of Hi-Power® II Belts & Truflex® V-Belts

- Gates Curves provide proper cord support and full contact with the sheave-groove for uniform loading, uniform wear, and increased belt life
- Flex-Bonded Cords are strongly bonded to the body of the belt resulting in equal load distribution and the absorption of bending stress without cord reduction
- Flex-Weave® Cover is a patented fabric construction for longer cover life, providing extended protection to the belt core from oil, dirt and heat
- Meets RMA static conductivity requirements
- Meets RMA oil and heat resistant standards

Tri-Power® Belts

Constructed with Gates proprietary construction, this belt has a superior combination of flex and load carrying capacity, as well as less stretch resulting in less maintenance.

Applications: Suitable for all industrial applications, particularly where small or sub-minimal sheave diameters are required.

Gates Super HC® Molded Belts

Constructed with Gates proprietary construction, this belt has a superior combination of flex and load carrying capacity, as well as transmitting more horsepower than the classical cross sections in the same amount of drive space.

Applications: Suitable for all industrial applications, particularly where space, weight and horsepower capacity are critical.

Features & Benefits of Tri-Power Belts & Gates Super HC® Molded Belts

- Flex-Bonded Cords are strongly bonded to the body of the belt resulting in equal load distribution and the absorption of bending stress without cord deterioration.
- Meets RMA oil and heat resistant standards.
- Meets RMA static conductivity requirements.
- Notches molded into the belt during manufacturing make this belt well suited for drives with smaller diameter sheaves.
- Belt Edge is machined for even sheave groove contact resulting in less slip and wear

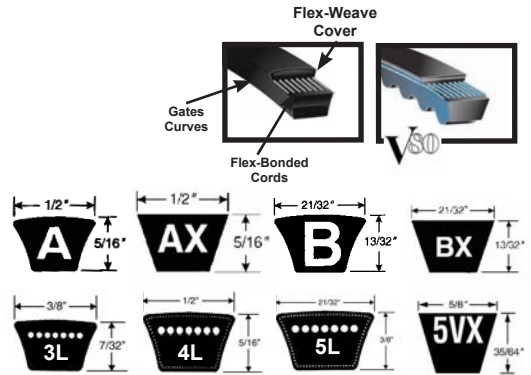

MARS#	Desc.	MARS#	Desc.
3L Belts		A Belts	
74103	3L170	74339	A35
74104	3L180	74340	A36
74105	3L190	74342	A38
74106	3L200	74343	A39
74107	3L210	74344	A40
74108	3L220	74348	A44
74109	3L230	74350	A46
74110	3L240	74352	A48
74111	3L250	74353	A49
74112	3L260	74355	A51

4L Belts		AX Belts	
74157	4L190	74566	AX26
74158	4L200	74554	AX32
74159	4L210	74569	AX35
74160	4L220	74570	AX36
74162	4L230	74572	AX38
74163	4L240	74573	AX40
74164	4L250	74604	AX44
74165	4L260	74577	AX46
74166	4L270	74578	AX48
74167	4L280		

5L Belts		B Belts	
74265	5L430	74430	B38
74267	5L450	74432	B40
74270	5L480	74434	B42
74275	5L530	74438	B46
74276	5L540	74440	B48
74277	5L550	74442	B50
74278	5L560	74443	B51
74279	5L570	74447	B55
74280	5L580	74448	B56
74289	5L670	74454	B62

5VX Belts		BX Belts	
74697	5VX1120	74619	BX46
74698	5VX1150	74620	BX48
74699	5VX1180	74621	BX50
74701	5VX1400	74607	BX51
74712	5VX450	74632	BX62
74713	5VX560	74635	BX66
74715	5VX600	74637	BX68
74702	5VX670	74638	BX70
74703	5VX710	74646	BX75
74708	5VX780	74643	BX81



3 Pole Mini-Split Disconnect Switch

Local codes require a disconnect switch to safely shut off power for indoor mini-split AC and Heat Pumps. The disconnect switch will break both power lines L1 and L2 along with the high voltage communicating line to meet local code requirements.

- UL 30 amp rated motor disconnect
- 3 pole
- 600V max

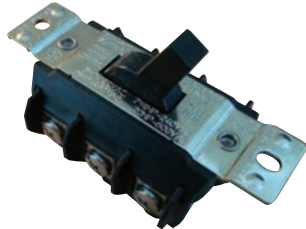

MARS NO.	DESCRIPTION	MARS PACK	CASE QTY
84711	30A-600V 3 Pole 3Ph AC Motor Switch(Bulk)	1	100

MARS Flexible Mini-Split Line Set Connectors

MARS flexible line set connectors provide ease of installation for mini-split indoor evaporator units. Flexible line sets allow for line set connection prior to mounting the unit on the wall. Flexible line sets eliminate copper line kinking during the installation process and provide for future ease of service of the AC unit. All flex line sets are 36in. in length to facilitate installation of wall mount evaporators.

Features:

- High pressure stainless steel braided line rated to 800 psi
- R410a compatible
- 3 inch copper stubs
- 36 inch overall length



MARS NO.	DESCRIPTION	CASE QTY
52345	1/4" X 36" Mini Split Flex Line Set	1
52346	3/8" X 36" Mini Split Flex Line Set	1
52347	1/2" X 36" Mini Split Flex Line Set	1
52348	5/8" X 36" Mini Split Flex Line Set	1

MARS Mini-Split Run Capacitors

MARS mini-split motor run capacitors are epoxy/resin sealed and widely used as the start-up and/or run capacitor for your motor. They feature very small dissipation factor and inherent temperature rise, high insulation resistance, and stable capacitance.

Technical Specification:

- Ambient temperature: 70° C
- Rated voltage: 450 VAC
- Capacitance tolerance: ±5
- 50/60 Hz
- Standard: IEC252-2001

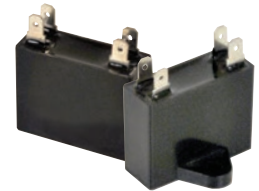

MARS NO.	DESCRIPTION	DIMENSIONS		
		H	D	W
12380	1 MFD X 450V	1-1/2 X	1/2 X	1
12381	1.5 MFD X 450V	1-1/2 X	1/2 X	1
12382	2 MFD X 450V	1-1/2 X	1/2 X	1
12383	2.5 MFD X 450V	1-1/2 X	3/4 X	1-1/4
12384	3 MFD X 450V	1-1/2 X	3/4 X	1-1/4
12385	3.5 MFD X 450V	1-7/8 X	3/4 X	1-3/8
12386	4 MFD X 450V	1-7/8 X	3/4 X	1-3/8
12388	5 MFD X 450V	1-7/8 X	7/8 X	1-3/8
12390	6 MFD X 450V	1-7/8 X	1 X	1-1/2

MARS Universal Remote Control for Mini-Split Units

MARS Universal Remote will operate with virtually any mini-split produced in any region of the world. Programming is accomplished by inputting your mini-split brand code or use the easy and intuitive self learn mode to set-up the remote to operate your mini-split. Operates with 2 AAA batteries.

- One touch function with LCD display
- Braille enabled
- Celsius or fahrenheit display
- Clock display
- 24 Hr. on/off timer for energy savings
- Displays room temperature
- Energy saver feature
- Automatically determines heat or cool mode



MARS NO.	DESCRIPTION	MARS PACK
65775	Mini-Split Universal Remote	1

MARS Concentric Vent Kits

MARS Concentric Vent Kits provide a single wall or roof penetration solution for high efficiency gas furnaces. Concentric vents save time and money by streamlining installation compared to the traditional 2 pipe system. Concentric vents also improve the aesthetics of the home by reducing the number of wall and roof penetrations. All necessary fittings are included in the kit. (The installing contractor needs to supply pipe and fittings between the furnace and concentric vent.)

- UL Approved
- Available in 2" and 3" kits
- Single Wall / Roof penetration
- White PVC



72956 72950
72957 72951

MARS NO.	DESCRIPTION
72950	2" Concentric Vent Kit
72951	3" Concentric Vent Kit
72956	2" Repl Cap for 72950
72957	3" Repl Cap for 72951

MARS Horizontal Vent Terminal Kits

MARS Horizontal Vent Termination Kits are designed for use with high efficiency condensing gas furnaces. The kit provides a low profile means of terminating exterior PVC intake and exhaust wall penetrations.

- Low Profile Design
- Hides Vent Pipes for a clean and finished look
- Designed for use with High Efficiency Gas Furnaces
- Kit includes mounting hardware



MARS NO.	DESCRIPTION
72952	2" Horizontal Vent Termination Kit
72953	3" Horizontal Vent Termination Kit

Expanding Insulation Foam Sealing Products

Expanding insulation sealant is quick and easy to use. It expands to fill holes, cracks, gaps and voids around pipes, outlets, vents and foundations.



93268

93267

MARS NO.	DESCRIPTION	MARS PACK	CASE QTY
93268	Foam sealant 12 oz.	12	12
93267	Foam sealant 20 oz.	12	12

MARS Putty

MARS Putty is non-hardening, non-toxic and can be shaped by hand to any form, and reused if necessary, for plugging openings through foundations, sealing around electrical boxes, refrigeration tube entry and so much more.



93520

Cross Reference

MARS No.	Bramec
93520	1003
93522	1004

MARS NO.	DESCRIPTION	MARS PACK	CASE QTY
93520	1 lb. Slug - Boxed	1	50
93521	5 lb. Slug - Boxed	1	10
93522	2 lb. Slug - Boxed	1	24

Heat Resistant Silicone



MARS NO.	DESCRIPTION	MARS PACK	CASE QTY
93255	Hi-Temp. silicone Red	10.1 oz.	12

Fireblock Foam Sealant

Fireblock Foam Sealant impedes the spread of fire and smoke through service penetrations. The foam has an identifiable orange color and can be delivered through stud walls. The insulating foam sealant can be used both indoors and outdoors so your whole property is covered.



MARS NO.	DESCRIPTION	CASE QTY
93195	Fireblock Foam Sealant Orange	12 FL Oz 12

Truck And Equipment Tarps

MARS equipment tarps provide a durable blue protective covering for truck beds, construction material and contractors tools.

- Rust-proof aluminum grommets
- All edges heat-sealed and reinforced with woven polyethylene yarn for durability
- Waterproof and UV resistant



MARS NO.	DESCRIPTION	MARS PACK	CASE QTY
79115	8' x 10' blue tarp	1	20
79116	12' x 12' blue tarp	1	12



Easy to Install



Key or Combination Lock



Set Your Own Code



Control Energy Costs



Scan for Installation Video



Scan for How to Change the Code Video



70256



Prevent tampering and unauthorized access.

- Fits Thermostats up to 7.25"W x 4.75"H x 2.25"D
- Back plate Dimensions:
 - o Exterior 9.25" x 6"
 - o Interior 4.75" x 7"
- Easy Installation

MARS NO.	DESCRIPTION	PACK QTY	CASE QTY
70256	Universal Thermostat Cover/Guard	1	24

Thermostat Guards

MARS thermostat guards are ideal for protecting thermostats in schools, industrial plants institutions, public facilities and other areas where unauthorized tampering could be a problem. These attractive units feature a rugged, light weight and compact design. All units supplied with key. Extra keys are available. Order part #70236 for the BTG thermostat guard key.

Thermostat Guards Cross Reference

MARS NO.	BEKO	D Teck	SUPCO
70201	BTG EK	585-TG5	BTG EK
70205	BTG K clear plst	585-TG2	BTG K
70210	BTG RK clear plastic	585-TG1	BTG-RK
70215	BTG 54VL metal	585-TG7	BTG-54 VL
70216	BTG 54VLW hinged metal	585-TG8	BTG-54VLW
70217	BTG DK clear plastic	585-TG6	BTG-DK
70220	BTG UK2 clear plastic	585-TG	BTG-UK2
70223	BTG UM metal	585-TG3	BTG-UM
70224	BTG UWM hinged metal	585-TG4	BTG-UWM
70236	F336 key		



70224



70201

70220

Broadest Selection of Popular Models All Metal, Clear Plastic and Opaque Plastic Designs

Plastic Thermostat Guards

MARS NO.	DESCRIPTION	BASE	MARS PACK	CASE QTY
70201	BTG-EK clear plastic cover	Solid	1	12
70205	BTG-K clear plastic cover	Dual	1	12
70210	BTG-RK clear plastic cover	Dual	1	12
70217	BTG-DK clear plastic	Dual	1	12
70220	BTG-UK2 clear plastic	Dual	1	12

Metal Thermostat Guards

MARS NO.	DESCRIPTION	BASE	MARS PACK	CASE QTY
70215	BTG-54VL metal hinged	Solid	1	12
70216	BTG-54VLW metal hinged	Ring	1	12
70223	BTG-UM metal	Solid	1	12
70224	BTG-UWM metal	Ring	1	12

Replacement Key

MARS NO.	DESCRIPTION	MARS PACK	CASE QTY
70236	F336, extra key for all BTG guards	1	1

MARS Cork Tape - 1/8" x 2" x 30' Roll

MARS Cork Tape is ozone resistant and specially designed for all types of climate. It insulates cold pipes for all kinds of air conditioners, freezers, and refrigerators. Cork Tape helps stop condensation problems. It is ideal for retarding heat gain in cold pipes and prevents heat loss in hot pipes. Can also be used for gasketing purposes. MARS Cork Tape sticks to all kinds of dry metals. This flexible tape seals tightly without drying. Temperature range: -20°F to 200°F / -29°C to 93°C.

Corktape is made from virgin cork specially imported from Portugal & Spain and has the following characteristics:



Thickness To Prevent Pipe Condensation

Ambient Temperature & %RH	Pipe Temperature	
77°F (25°C) & 50% RH	50°F (10°C)	32°F (0°C)
85°F (29°C) & 70% RH	Double Layer	Triple Layer
	plus Double Layer	Plus Triple Layer

MARS NO.	DESCRIPTION	MARS PACK	Case Qty
93505	Cork Tape	1	12

MARS Foam Tape - 1/8" x 2" x 30' Roll

MARS Foam Tape is a self-adhering closed cell thermal insulation tape. This flexible tape is ideal for wrapping hot or cold pipings and fittings. The energy saving and very easy to use Foam Tape is excellent for preventing condensation problems. MARS Foam Tape is designed for retarding heat loss in hot pipings and preventing heat gain or frost formation on cold, chilled water pipings or refrigerant lines. Adheres firmly to all metals. Temperature range: -20°F to 200°F / -29°C to 93°C.



Thickness To Prevent Pipe Condensation

Ambient Temperature & %RH	Pipe Temperature	
80°F (27°C) & 50% RH	50°F (10°C)	35°F (0°C)
85°F (30°C) & 70% RH	Single Layer	50% Overlap
	50% Overlap	50% Overlap
	plus Single Layer	Plus 50% Overlap

MARS NO.	DESCRIPTION	MARS PACK	Case Qty
93506	Foam Tape	1	12

Black Mamba Gloves

- Made with a patented NITREX® polymer
- Super strong (6.0 mils) powder free nitrile glove
- 3 times the chemical and puncture resistance of a comparable thickness latex or vinyl glove
- Grip rite finish for secure handling.



MARS NO.	DESCRIPTION	MARS PACK	CASE QTY.
79200	Black Nitrile Gloves – L 100/box	1	10
79138	Black Nitrile Gloves – XL 100/box	1	10

Rooftop Support Systems

Economy CX-Series

- Base only
 - Material – 100% recycled rubber, UV resistant
- CX Series rooftop support is designed as an economic alternative when a high load bearing is not required. They are perfect for supporting conduit or smaller pipe.

C-Series

- Material – 100% recycled rubber, UV resistant
- C Series channel support is designed for superior support of gas and refrigeration piping systems, cable tray, electrical conduit multiple lines, HVAC equipment and many other applications.

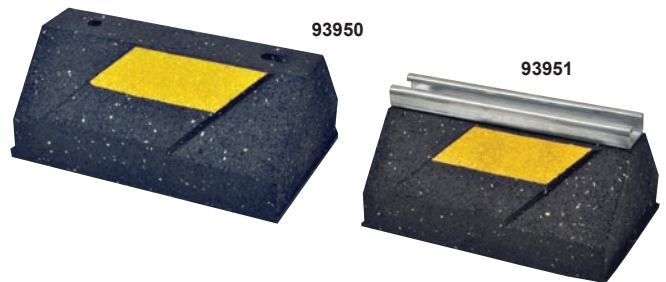

MARS NO.	DESCRIPTION	MARS PACK	Case Qty	MAX. Load
93950	CX-Series 4" H x 6" W x 9.6" L	1	240	500 lbs./ft.
93951	C-Series 4 7/8" H x 6" W x 9.6" L	1	200	700 lbs./ft.

Energizer Batteries - Blister Pack *Energizer*



MARS NO.	DESCRIPTION	MARS PACK	CASE QTY.
79441	D cell - 2 pack	12	48
79442	C cell - 2 pack	12	48
79443	AA - 4 pack	12	48
79444	AAA - 4 pack	12	48
79445	9V - 2 pack	12	48
79457	AAAA - 2 pack	6	6

Energizer Industrial Alkaline - Bulk *Energizer*

MARS and the Energizer Battery Company offer a complete line of alkaline, general purpose and lantern batteries. These high quality batteries are made in the U.S.A. and are competitively priced.

The Energizer Industrial Alkaline batteries are environmentally safe and are mercury-free, designed for long-lasting power in high drain, frequent use applications. Batteries are sealed and have excellent leakage resistance and a long storage life. This provides a better discharge rate, lower impedance and better low temperature performance than carbon zinc. These ZMA alkaline batteries are also less sensitive to changes in the discharge rate or duty cycle.

79401



MARS NO.	DESCRIPTION	MARS PACK	CASE QTY.
79401	D cell - 1.5V	12	72
79402	C cell - 1.5V	12	72
79403	AA - 1.5V	24	144
79404	AAA - 1.5V	24	144
79405	9V	12	72

Stainless Steel Vibration Absorbers

- 100% Copper connections
- Hose and copper braze welded
- Each unit dehydrated and vacuum tested
- Units individually packaged in poly bags and corrugate boxes
- UL, cUL, and CE



MARS NO.	DESCRIPTION	MARS PACK
52329	1/4" Vibration Absorber	1
52330	3/8" Vibration Absorber	1
52331	1/2" Vibration Absorber	1
52332	5/8" Vibration Absorber	1
52333	3/4" Vibration Absorber	1
52334	7/8" Vibration Absorber	1
52335	1-1/8" Vibration Absorber	1
52336	1-3/8" Vibration Absorber	1
52337	1-5/8" Vibration Absorber	1
52338	2-1/8" Vibration Absorber	1
52339	2-5/8" Vibration Absorber	1
52340	3-1/8" Vibration Absorber	1

Compressor Terminal Repair Kit

Zebra Instruments offers a compressor terminal repair kit. The terminals are high-temp soldered to the 10ga. fine strand, color coded wires for the best connection. These special terminals allow clearance for compressor post, and lay flat under the safety cover. Twist on wire nuts also provided.



MARS NO.	DESCRIPTION	MARS PACK	CASE QTY.
08565	Compressor Terminal Repair Kit 1 set of 3, terminals/wires/connectors	1	24

Leading the Way in ECM Technology

AZURE[®] ECM



AZURE[®] ECM

PSC Condenser Fan Applications



825 & 1075 RPM Motor in One

Easy to Mount

- The short shell 1/3 HP (MARS No.10874) fits where larger competitive motors will not

Easy to Configure

- Simply power the motor to cycle it through 4 possible configurations and lock in the desired mode

1075 RPM CW • 1075 RPM CCW • 825 RPM CW • 825 RPM CCW

Simple 2 Wire Installation

- Connect the 2 motor leads directly to the definite purpose contactor; there are no capacitor, rotation, or RPM jumper wires

Outboard Surge Protection

- Unique to Azure[®] is the replaceable outboard surge protector included within the wire harness of each Azure[®] condenser fan motor

Replaces PSC Motors, Only

Features:	Benefits:
Multi HP, reversible, 825/1075 RPM	Reduces truck stock
High efficiency	Reduces energy consumption
Ball bearing	Provides quiet operation
No capacitor required	Improves reliability
Rheem mounting holes (10874)	Fits Rheem equipment
2 year warranty	Provides peace of mind

MARS NO.	HP	VOLTS	RPM	ROTATION	ORIENTATION	RHEEM HOLES
10874	1/8-1/3	208-230	825/1075	REV	Shaft Down	Yes
10872	1/3-1/2	208-230	1075	REV	Horizontal	No
10875	1/8-1/3	208-230	1075	REV	Horizontal	No

AZURE[®] ECM

Variable Speed, Constant Torque, and PSC Replacement Motors



- ✓ **Simple Drop-In Installation**
- ✓ **Adjustable Torque Optimizes CFM**
- ✓ **Significantly Reduces Truck Stock & Carrying Cost**
- ✓ **Ball Bearing**
- ✓ **2 Year Warranty**

Wired Hand Held Programmer For Select Azure Blower Motors*

- Manually adjust any speed tap up to 80 different settings
- Dial in CFM during heat rise tests
- Optimize airflow
- Create custom low speed for constant fan



MARS NO.	DESCRIPTION
08502	Hand Held Programmer for 10860/10861/10865/10866/10867/10868/10869

MARS NO.	DIA.	HP	VOLTS	RPM	ROTATION	BLUETOOTH CONTROL	REPLACES
10856	5.5"	1/4-1/2	115/230	1075 Variable	REV	Yes	Variable Speed ECM
10857	5.5"	1/2-1	115/230	1075 Variable	REV	Yes	Variable Speed ECM
10858	5.5"	1/5-1/2	115/230	1075	REV	Yes	Constant Torque
10859	5.5"	1/2-1	115/230	1075	REV	Yes	Constant Torque
10860*	5.5"	1/5-1/2	115/230	1075	REV	No	PSC/Constant Torque
10861*	5.5"	1/2-1	115/230	1075	REV	No	PSC/Constant Torque
10867*	5.0"	1/8-1/3	115/230/277	1075	REV	No	PSC
10865*	5.5"	1/3-1/2	115/230	1075	REV	No	PSC
10866*	5.5"	3/4-1	115/230	1075	REV	No	PSC

Got an OEM Variable Speed ECM with one of these connectors?



4 Pin Variable Speed



16 Pin Variable Speed

Replace it with Azure. Azure connects directly to OEM harnesses.

- ✓ **Bluetooth Control**
Free app (AZURE ECM) is available on both Apple and Google stores.
- ✓ **Intuitive**
Drop down menus and data inputs are simple and make sense.
- ✓ **Plug and Play**
Azure connects directly to OEM harnesses; additional module or adapter is not required.
- ✓ **Adjustable Airflow**
The app allows optimization of airflow even if ductwork is not optimal.
- ✓ **Ultimate Truck Stock**
Save time and money. Two Azure ECMs replace A LOT of motors!
- ✓ **Replaces** 16 Pin OEM Variable Speed ECM, PWM, 2.0, 2.3, 2.5 EON®; and Evergreen® VS, Rescue® EZ16®
- ✓ **Replaces** Many* 4 Pin OEM Variable Speed ECM 3.0; and Evergreen® VS



Bluetooth inside

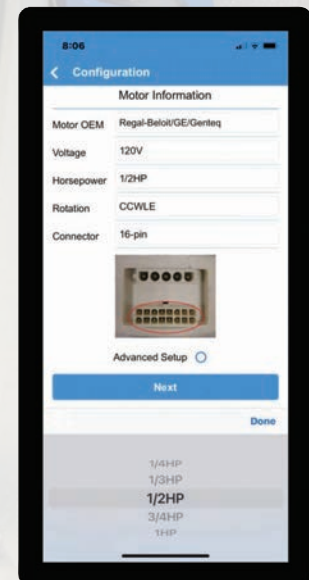

Smartphone not included

MARS No.	HP	Volts	RPM	Rotation	Diameter
10856	1/4-1/2	115/230	1075 Variable	REV	5.5"
10857	1/2-1	115/230	1075 Variable	REV	5.5"

*Due to proprietary OEM protocol, some communicating ECMs may not be compatible with Azure.

AZURE[®] ECM

Walk-In Cooler Applications

Drop in 3.3" ECM replaces most OEM / ECM / PSC and standard shaded pole commercial refrigeration evaporator fan motors up to 1/15 HP for walk-in cooler/freezer applications. Smart micro-processor automatically adapts to the fan load up to 1/15HP and voltage up to 230V. With the Azure ECM app (available for download from the Google Play and Apple stores), speed and rotation can be field programmed using a smart phone and the optional wireless programming kit. A thermistor kit can convert the motor to 2-speed operation without the need for a separate 2-speed controller.

Specifications:

Horsepower:	1/15 - 1/25
Voltage:	115/230
Amps (Max)	1.3/0.65
Efficiency:	68%
Estimated Energy Savings:	\$65/year (\$91/year total) ⁽¹⁾
Operating Range:	-40° to 131°F
OL Protection:	Electronic
Bearing:	Ball
Wire Connector:	Lyall Plug
Listings:	UL/cUL

MARS NO.	RPM	SPEEDS	ROTATION	PROGRAMMABLE
10850	1550	1	Rev	No
10852	1550*	1 or 2**	CCWLE***	Yes

* 1550 default; adjustable 600-2000 RPM with optional wireless programmer kit (MARS No. 08505)

** 2-speeds attainable with optional wireless programmer kit (MARS No. 08505) and optional thermistor kit (MARS No. 08515)

*** CCWLE default; reversible with optional wireless programmer kit (MARS No. 08505)

⁽¹⁾ Estimated energy savings based on replacement of a 1/20 HP shaded pole evaporator fan motor with Azure[®] at \$0.11/kWh. \$65 savings is based solely on the reduction of power consumption. An additional savings of approximately 40% will result from the reduction of the refrigeration load due to Azure[®]'s lower operating temperature.



Reach-In Cooler/Case Applications

Submersible watt motor replaces most OEM / ECM / PSC and standard shaded pole commercial refrigeration evaporator and condenser fan motors 4 - 25 W for reach-in cooler/freezer applications. The microprocessor sets power output to match the fan load ensuring correct CFM and maximum efficiency in every installation. With the Azure ECM app (available for download from the Google Play and Apple stores), speed and rotation can be field programmed using a smart phone and the optional programming kit.

Specifications:

Wattage:	4 - 25
Voltage:	115/230
Amps (Max)	0.47/0.33
Efficiency:	68%
Estimated Energy Savings:	\$33/year (\$46/year total) ⁽²⁾
Operating Range:	-40° to 131°F
OL Protection:	Electronic
Bearing:	Ball
Wire Connector:	90° Angle Lyall Plug
Listings:	UL/cUL
IP Rating:	IP 67 (Submersible)

MARS NO.	RPM	SPEEDS	ROTATION	PROGRAMMABLE
10891	1550*	1	CWLE***	Yes

* 1550 default; adjustable 600-2000 RPM with optional wireless programmer kit (MARS No. 08505)

*** CWLE default; reversible with optional wireless programmer kit (MARS No.08505)



⁽²⁾ Estimated energy savings based on replacement of a 9 W shaded pole evaporator fan motor with Azure[®] at \$0.11/kWh. \$33 savings is based solely on the reduction of power consumption. An additional savings of approximately 40% will result from the reduction of the refrigeration load due to Azure[®]'s lower operating temperature.

Power Consumption		
Fan Load	Standard Motor Power Consumption	Azure [®] Power Consumption
1/20 HP	105 W	43 W
1/15 HP	139 W	57 W

Power Consumption		
Fan Load	Standard Motor Power Consumption	Azure [®] Power Consumption
4 W	28 W	6 W
9 W	47 W	14 W
16 W	77 W	30 W

Commercial Refrigeration Motors Programmable to Meet Your Needs

Out of the box, the programmable Azure 3.3 and Azure watt motors are set to meet the majority of your application requirements. Need more flexibility? Plug the optional wireless programmer into either motor and use your smart phone to change both the speed and rotation to meet nearly any application requirement including OEM.

Need more efficiency? Plug the optional thermistors into the 3.3 motor and use the programming kit to set up 2-speed operation. The motor will sense the refrigeration cycles and operate at normal speed during the on call and then low speed during the off call for enhanced energy savings.

Simple Operation

- Step 1:** Download the Azure ECM App to your Apple or Android smart phone/tablet.
- Step 2:** Connect the wireless programmer to the motor.
- Step 3:** Open the App and make adjustments to motor speed and rotation.



10852



10891

MARS NO.	DESCRIPTION	AZURE® MOTOR COMPATIBILITY
08505	Wireless Programmer Kit; Requires Azure ECM App and Smart Device (sold separately)	10852, 10891
08515	Thermistor Kit for 2-Speed Operation (1 Pair); Controls up to 5 Motors	10852

Videos

Scan with your smartphone or see us on YouTube and marsdelivers.com under Resources.

Compatibility: Azure® watt motor (MARS No. 10891) / Azure® 3.3 motor (MARS No. 10852)

The Azure® Wirelessly Programmer is available from:

Android Smart Devices: (Azure ECM app required). Download from your On-line app store.

Apple Smart Devices: (Azure ECM app required). Download from your On-line app store.



Azure Wireless Programmer Kit



Programming the Azure Watt Motor



Programming the Azure 3.3 Motor



Azure 2-Speed Motor Retrofit



Outdoor Condenser Fan Motors

Ball Bearing

Features / Specifications:

- All angle mount
- Rheem mounting holes w/screws installed
- Single phase, 60 Hertz
- Thermal overload protected
- Fan duty, continuous, air over
- Totally enclosed • UL Recognized

Reversible Rotation - Single Speed - 208-230 Volts

MARS NO.	HP	AMPS	CAP REQUIRED
----------	----	------	--------------

1075 RPM

10725	1/8	0.72	5/370
10727	1/6	0.90	5/370
10726	1/5	1.17	5/370
10728	1/4	1.8	5/370
10729	1/3	2.4	7.5/370
10730	1/2	3.5	10/370
10731	3/4	4.7	10/370

825 RPM

10411	1/8	0.80	5/370
10403	1/6	1.0	5/370
10412	1/5	1.3	5/370
10404	1/4	1.6	5/370
10405	1/3	1.9	7.55/370
10746	1/2	2.8	12.5/370

Ball Bearing

Features / Specifications:

- All angle mount
- Rheem mounting holes w/screws installed
- Single phase, 60 hertz
- Thermal overload protected
- Totally enclosed • UL Recognized

Reversible Rotation - Single Speed - 208-230 Volts

MARS NO.	HP	AMPS	CAP REQUIRED
----------	----	------	--------------

1075 RPM

10732	1/6	0.90	5/370
10733	1/4	1.8	5/370
10734	1/3	2.4	7.55/370
10735	1/2	3.5	10/370
10736	3/4	5.2	10/370

825 RPM

10203	1/6	1.0	5/370
10204	1/4	1.6	5/370
10205	1/3	1.9	7.5/370
10747	1/2	2.8	12.5/370





Multi-Horsepower Condenser Fan Motors

Ball Bearing

Features / Specifications:

- Rheem mounting holes w/screws installed
- Air conditioning or heat pump duty
- Single phase, 60 Hz
- Thermal overload protected • UL Recognized

Reversible Rotation - Single Speed - 208-230 Volts

MARS NO.	HP	RPM/SPEED	CAP REQUIRED
10458	1/6 - 1/3	1075	7.5/370
10459	1/8 - 1/3	825	10/370
10465	1/6 - 1/3	1075/2	5/7.5/370
10468	1/5 - 1/2	1075/2	10/12.5/370
10469	1/6 - 1/3	825/2	10/7.5/370



Super-Fit™ Multi-Horsepower Condenser 42 Frame Fan Motors

Ball Bearing

Features / Specifications:

- Super-Fit™ mounting holes for Trane 4.33, 4.42 and 4.62 bolt circle mounting. Includes self threading screws
- All angle mount
- Single phase, 60 Hz • Thermal overload protected
- UL Recognized

Reversible Rotation – Single Speed - 208-230 Volts

MARS NO.	HP	AMPS	RPM	CAP REQUIRED
10722	1/8, 1/10, 1/12	0.75	1075	5/370
10723	1/4, 1/5, 1/6	1.5	1075	7.5/370
10724	1/4, 1/5, 1/6	1.35	1625	5/370

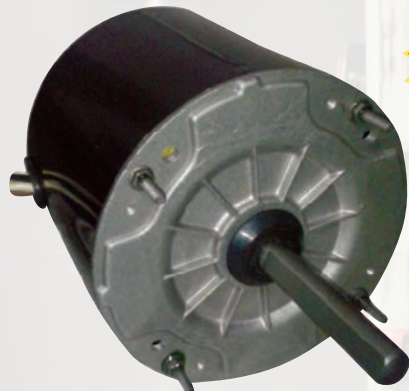

Outdoor Condenser Fan Motors Shaft Up Only

Features / Specifications:

- Rheem mounting holes w/screws installed
- Single phase, 60/50 Hertz
- Automatic thermal overload protected • UL Recognized

**Reversible Rotation - 1075 RPM
Single Speed - 208/230 Volts**

MARS NO.	HP	AMPS	BEARING	CAP REQUIRED
10327	1/6	0.9	Sleeve	5/370
10328	1/4	1.8	Sleeve	5/370
10329	1/3	2.4	Sleeve	7.5/370
10330	1/2	3.5	Ball	10/370
10331	3/4	5.2	Sleeve	10/370





Outdoor Condenser Fan Motors

Ball Bearing - 70°C

Features / Specifications:

- All angle mount
- Rheem mounting holes w/screws installed
- Trane 4.33 bolt circle mounting holes with self tapping screws
- Single phase, 60 Hertz
- 70°C/158°F
- Thermal overload protected
- Fan duty, continuous, air over
- Totally enclosed
- UL Recognized

Reversible Rotation - Single Speed - 208-230 Volts

MARS NO.	HP	AMPS	CAP REQUIRED
1075 RPM			
20727	1/6	0.90	5/370
20728	1/4	1.8	5/370
20729	1/3	2.4	7.5/370
20730	1/2	3.5	10/370
20731	3/4	5.2	10/370
825 RPM			
20402	1/8	0.75	5/370
20403	1/6	1.0	5/370
20404	1/4	1.6	5/370
20405	1/3	1.9	7.5/370
20746	1/2	2.8	12.5/370



460V Outdoor Condenser Fan Motors – Shaft Up Only

Ball Bearing - 70°C

Features / Specifications:

- Rheem mounting holes w/screws installed
- Single Phase, 60 Hz
- 70°C, 158°F
- Thermal overload protected
- Totally enclosed
- UL Recognized

Reversible Rotation - 1075 RPM - Single Speed

MARS NO.	HP	AMPS	CAP REQUIRED
20846	1/4	0.65	7.5/440
20847	1/3	0.90	7.5/440
20848	1/2	1.3	10/440
20849	3/4	2.05	10/440





460V Outdoor Condenser Fan Motors

Ball Bearing - 70°C

Features / Specifications:

- All angle mount
- Rheem mounting holes w/screws installed
- Trane 4.33 bolt circle mounting holes and self tapping screws
- Single phase, 60 Hz
- 70°C/158°F
- Thermal overload protected
- Totally enclosed
- UL Recognized



Reversible Rotation – 1075 RPM – Single Speed

MARS NO.	HP	AMPS	CAP REQUIRED
20835	1/6	0.48	5/440
20836	1/4	0.65	7.5/440
20837	1/3	0.90	7.5/440
20838	1/2	1.3	10/440
20842	3/4	2.0	10/440

Reversible Rotation – 825 RPM – Single Speed

20859*	1/6	0.53	5/440
20880	1/4	0.90	5/440
20881	1/3	1.0	7.5/440
20882	1/2	1.55	10/440

Reversible Rotation – 1075 RPM – Multi-HP

20478	1/3 - 1/6	1.2	7.5/370
20479	1/2 - 1/5	1.5	10/370
20480	1/2 - 1/6	1.46	10/440
20481	3/4 - 1/4	2.12	15/440

One-On-One™ Replacement Motor for AO Smith ORM4688BF

MARS NO.	HP	ROT	RPM/SPDS	AMPS	CAP REQUIRED
20884	1/8, 1/6, 1/5, 1/4, 1/3	REV	825/1	1.0	7.5/370

* CW Rotation-opposite shaft end





High Efficiency Direct Drive Blower Motors – MARS Energy Master

Ball Bearing - 70°C

Features / Specifications:

- 12-15% more efficient compared to standard motors
- Rheem mounting holes
- 2-1/4 inch resilient rings - plus 2-1/2 inch split rings included
- Single phase, 60 Hertz
- Fan duty, continuous air over
- Automatic thermal overload protection
- UL Recognized

1075 RPM – Reversible Rotation – Three Speed

MARS NO.	HP	VOLTS	AMPS	CAP REQUIRED
10573	1/4	115	2.9	7.5/370
10574	1/4	208-230	1.3	5/370
10575	1/3	115	3.9	10/370
10576	1/3	208-230	1.6	7.5/370
10577	1/2	115	5.2	15/370
10578	1/2	208-230	2.5	10/370
10579	3/4	115	8.0	20/370
10580	3/4	208-230	3.5	15/370



MARS 48 Frame Torsion Flex Mount Motors

Features / Specifications:

- Sleeve bearing
- Torsion flex mount
- 4-1/2 inch long, 1/2 inch diameter shaft
- Torsion mount sleeves and grommets included
- Single phase, 60 Hertz
- Thermal overload protected
- Fan duty, continuous, air over
- UL Recognized

1075 RPM – Reversible Rotation – Three Speed

MARS NO.	HP	VOLTS	AMPS	CAP REQUIRED
10683	1/4	115	4.2	5/370
10684	1/4	208-230	1.8	5/370
10685	1/3	115	6.1	5/370
10686	1/3	208-230	2.7	5/370
10687	1/2	115	7.5	10/370
10688	1/2	208-230	3.2	7.5/370
10689	3/4	115	11.2	15/370
10690	3/4	208-230	4.5	10/370





460V Direct Drive Blower Motors

Ball Bearing - 70°C

Features / Specifications:

- All angle mount
- Class "B" insulation
- Single phase, 60 Hz
- Thermal overload protected
- UL Recognized

Cross Reference

MARS No.	GE/ Genteq	Century/ AO Smith	US Motors/ Emerson	Marathon	ROTOM
20538	-	-	-	X038	-
20580	3280	BDH1036	-	-	M2-R32712
20581	3290	BDH1076	8947	-	M2-R32426

Reversible Rotation

MARS NO.	HP	AMPS	CAP REQUIRED
----------	----	------	--------------

1075 RPM - Two Speed

20538	1/2	1.8	10/370
-------	-----	-----	--------

Multi-Horsepower – Reversible Rotation

MARS NO.	HP	AMPS	CAP REQUIRED
----------	----	------	--------------

1075 RPM - Two Speed

20580	1/3 - 1/4	0.95	7.5/370
20581	3/4 - 1/2	2.1	15/370

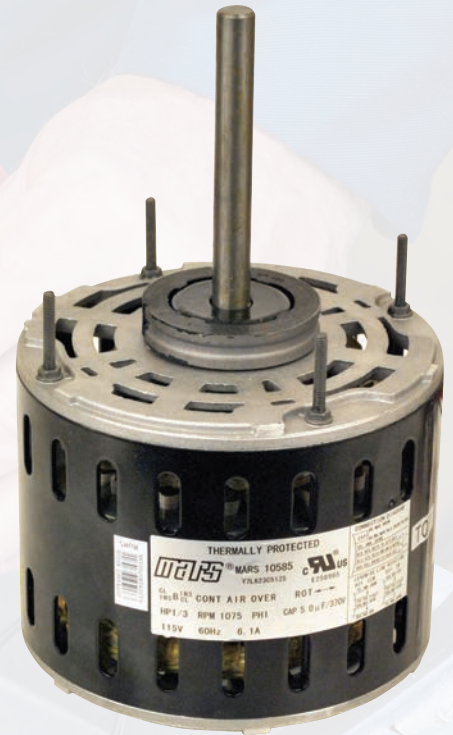

Belted Fan & Blower Motors w/Service Factor (S/F)

Ball Bearing - 70°C

Features / Specifications:

- Slotted holes in base match 48 or 56 frame bolt patterns
- Class "B" insulation
- Single phase, 60 Hz
- Thermal overload protected
- Continuous duty
- UL Recognized

1725 RPM - Single Speed – Reversible Rotation – 115 Volts – NEMA Frame 46/56

MARS NO.	HP	FLA	S.F.	COMPETITOR CROSS REFERENCE						
				AO Smith/ Century	Emerson/ US Motors	GE/ Genteq	Magnetek	Marathon	Packard	ROTOM
10401	1/4	4.3	1.35	GF2024, RB2024	2889, 8000	4701	808, 802	B303, B206	45014	BF-4701
10406	1/3	5.8	1.35	GF2034, RB2034	2888, 8100	4706	922, 805	B305, B207	45013	BF-4706
10408	1/2	7.7	1.25	GF2054, BF2054	2887, 8200	4708	F681, 811	B208	45012	BF-4708





Direct Drive Blower Motors

Features / Specifications:

- Sleeve bearings except as noted
- Rheem mounting holes
- Class “B” insulation
- Single phase, 60 Hertz
- Thermal overload protected
- Fan duty, continuous, air over
- UL Recognized

1075 RPM – Three Speed – Reversible Rotation

MARS NO.	HP	VOLTS	AMPS	CAP REQUIRED
10583	1/4	115	4.2	5/370
10584	1/4	208-230	1.8	5/370
10585	1/3	115	6.1	5/370
10586	1/3	208-230	2.7	5/370
10587	1/2	115	7.5	10/370
10588	1/2	208-230	3.2	7.5/370
10589	3/4	115	11.2	15/370
10590	3/4	208-230	4.5	10/370
10591 ¹	1	115	11.8	20/370
10592 ¹	1	208-230	5.6	15/370

¹ Ball Bearing

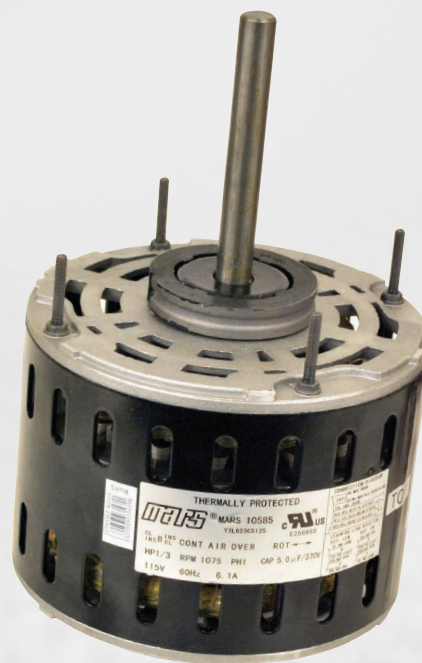

Multi-Horsepower Direct Drive Blower Motors

Features / Specifications:

- Sleeve Bearing
- Rheem mounting holes
- 2-1/4 inch resilient rings
- Class “B” insulation
- Single phase, 60 Hz
- Thermal overload protected
- UL Recognized

Four Speed – Reversible Rotation

MARS NO.	HP	VOLTS	RPM
10463	1/6 - 1/2	115	1075
10464	1/6 - 1/2	208-230	1075
10466	1/5 - 3/4	115	1075
10467	1/5 - 3/4	208-230	1075
10479	1/8 - 1/3	208-230	825





3.3" Commercial Refrigeration Multi-Horsepower Motors

These motors replace hundreds of OEM shaded pole evaporator fan motors found in Bohn, Nutone, Chandler, Larkin, Kramer, Climate Control, McQuay, Heatcraft and reduce truck stock costs.

These PSC type motors deliver more power and lower amp draw compared to shaded pole.

Features / Specifications:

- Sleeve bearing
- Mounting - extended thru-bolt with nuts
- Low temp lubricant
- Capacitor included
- Open ventilation
- Class "B" insulation
- 60 Hz
- Thermal overload protected
- Single speed

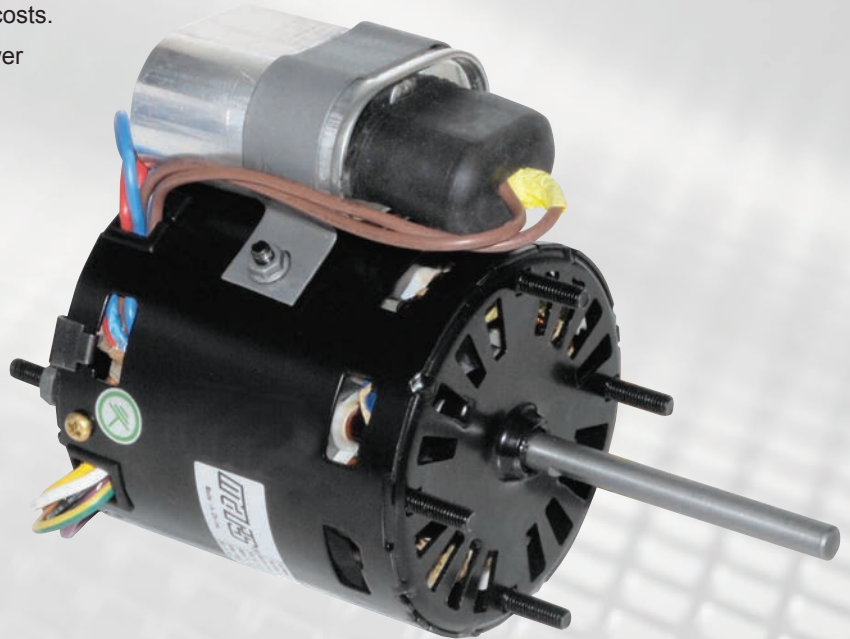

Replaces 12 Motor Ratings:

1/12HP	CW or CCW	115V or 230V
1/15HP	CW or CCW	115V or 230V
1/20HP	CW or CCW	115V or 230V

Cross Reference

MARS No.	Century/ AO Smith	US Motors/ Emerson	Fasco	GE/Genteq	OEM	Packard
01125	9720A	9656, 8658, 9664	7190-0442, D1125		253005101, 25309101, 7071061, 55034LS, 5034L, 5008SS and 50085 S58-486, 5008TS, 5008T, 5034MS and 5034M S58-776	41125
01127	9721	9650, 9651, 9652, 9653, 9656, 9662, 9664	D1101, D1103, D1122, D1123, D1124, D1125, D1126, D1127, D1152, D1154, PD1125, PD1127, 7163-2113, 7163-3371 7190-0442, 7190-2084 7190-2255, 7190-2285 7190-2969	5KSM59ES2001 5KSM59JSK143S 5KSM59JS5036S 5KSM59LS2262AS	25308601, 25309101, 2531194, 2531195 7071061	49101

1550 RPM

MARS NO.	HP	VOLTS	ROTATION	AMPS	CAP INCLUDED	SHAFT LENGTH AND DIAMETER
01125	1/12, 1/15, 1/18	208-230	CCW LE	0.56/0.50	4 MFD 370V	2.55 x 5/16
01127	1/12, 1/15, 1/20	115/230	REV	1.1/0.60	7.5 MFD 370V	3.00 x 5/16



Condenser Fan Motors

Ball Bearing

Features / Specifications:

- All angle mount
- Class "B" insulation
- Single phase, 60 Hz
- Thermal overload protected
- Fan duty, continuous air over
- UL Recognized

Reversible Rotation – Single Speed – 208-230 Volts

MARS NO.	HP	CAP REQUIRED
1075 RPM		
22727	1/6	5/370
22728	1/4	5/370
22729	1/3	7.5/370
22730	1/2	10/370
22731	3/4	10/370
825 RPM		
22403	1/6	5/370
22404	1/4	5/370
22405	1/3	7.5/370
22746	1/2	12.5/370



Multi-Horsepower Condenser Fan Motors

Ball Bearing

Features / Specifications:

- Air conditioning or heat pump duty
- All angle mount
- Class "B" insulation
- Single phase, 60 Hz
- Thermal overload protected
- UL Recognized

Reversible Rotation – 208-230 Volts

MARS NO.	HP	RPM/SPEED
22458	1/6 - 1/3	1075
22459	1/8 - 1/3	825
22465	1/6 - 1/3	1075/2
22468	1/8 - 1/2	1075/2
22469	1/6 - 1/3	825/2





Condenser Fan Motors

Ball Bearing

Features / Specifications:

- All angle mount
- Class "B" insulation
- Single phase, 60 Hz
- Thermal overload protected
- Fan duty, continuous air over
- UL Recognized
- 70°C, 158°F

Reversible Rotation – Single Speed – 208-230 Volts

MARS NO.	HP	CAP REQUIRED
1075 RPM		
26726	1/5	5/370
26727	1/6	5/370
26728	1/4	5/370
26729	1/3	7.5/370
26730	1/2	10/370
26731	3/4	10/370
825 RPM		
26403	1/6	5/370
26404	1/4	5/370
26405	1/3	7.5/370
26746	1/2	12.5/370

Multi-Horsepower Condenser Fan Motors

Ball Bearing

Features / Specifications:

- All angle mount
- Thru bolt or band mounting
- Class "B" insulation
- Single phase, 60 Hz
- Thermal overload protected
- UL Recognized
- 70°C, 158°F

Reversible Rotation – 208-230 Volts

MARS NO.	HP	RPM/SPEED
26458	1/6 - 1/3	1075
26459	1/8 - 1/3	825
26465	1/6 - 1/3	1075/2
26468	1/8 - 1/2	1075/2
26469	1/6 - 1/3	825/2





Direct Drive Blower Motors

Ball Bearing

Features / Specifications:

- All angle mount
- Class “B” insulation
- Single phase, 60 Hertz
- Thermal overload protected
- Fan duty, continuous, air over
- UL Recognized

Reversible Rotation – 1075 RPM – Three Speed

MARS NO.	HP	VOLTS	CAP REQUIRED
22583	1/4	115	5/370
22584	1/4	208-230	5/370
22585	1/3	115	5/370
22586	1/3	208-230	5/370
22587	1/2	115	10/370
22588	1/2	208-230	7.5/370
22589	3/4	115	15/370
22590	3/4	208-230	10/370



Multi-Horsepower Direct Drive Blower Motors

Ball Bearing

Features / Specifications:

- Class “B” insulation
- Single phase, 60 Hz
- Thermal overload protected
- UL Recognized

Reversible Rotation – 1075 RPM – Four Speed

MARS NO.	HP	VOLTS
22463	1/6 - 1/2	115
22464	1/6 - 1/2	208-230
22466	1/5 - 3/4	115
22467	1/5 - 3/4	208-230





51 Frame Unit Bearing Cast Iron

Features:

- Cast iron
- Shaded pole, single phase
- Impedance protected
- Class “A” insulation
- 60/50 Hertz
- Lead length 24”



Cast Iron

MARS NO.	WATTS	ROT OSE	VOLTS	AMPS
1550 RPM—1/4-20 Threaded Shaft - Dual Pad Mounting - Lyall Plug				
05211 ⁽¹⁾	4	CW	115	0.33
05212 ⁽¹⁾	4	CCW	115	0.33
05221 ⁽¹⁾	4	CW	230	0.19
05222 ⁽¹⁾	4	CCW	230	0.19
05311	6	CW	115	0.46
05312	6	CCW	115	0.46
05411	9	CW	115	0.62
05412	9	CCW	115	0.62
05421	9	CW	230	0.33
05422	9	CCW	230	0.33
05811 ⁽²⁾	16	CW	115	0.95
05812 ⁽²⁾	16	CCW	115	0.95
05821 ⁽²⁾	16	CW	230	0.48
05822 ⁽²⁾	16	CCW	230	0.48

(1) Class A Insulation (2) Automatic Reset Overload Protection



Watt Motors

Features / Specifications:

- Cast iron construction
- Universal mount
- Mounting screws included
- Individually boxed
- Class “A” insulation
- UL Recognized



JARD NO.	WATTS	VOLTS	ROTATION
15109	2	115	CW
15119*	9	115	CW
15211	4	115	CW
15212	4	115	CCW
15221	4	230	CW
15222	4	230	CCW
15311	6	115	CW
15312	6	115	CCW
15411	9	115	CW
15412	9	115	CCW
15421	9	230	CW
15422	9	230	CCW
15811	16	115	CW
15812	16	115	CCW
15821	16	230	CW
15822	16	230	CCW

* Note: 13 " lead with lyall plug

marathon[®] electric STOCK REPLACEMENT PRODUCTS

Single Phase Commercial Condenser Fan Motors

Where Used Air conditioning and heat pump condensers

Single Phase, PSC, Totally Enclosed, Air Over

MODEL NO.	HP	RPM	VOLTAGE	FRAME	COMPETITOR CROSS REFERENCE				
					AO SMITH/CENTURY	FASCO	GE	MAGNETEK	US MOTORS
X412	1/4	1075/1	208-230	48Y	FSE1026SV1	D909	3728	176	1860
X413	1/3	1075/1	208-230	48Y	FSE1036SV1	D908	3729	175	1861

Thru-Bolt, Shaft-Up or Horizontal

MODEL NO.	HP	RPM	VOLTAGE	FRAME	COMPETITOR CROSS REFERENCE				
					AO SMITH/CENTURY				US MOTORS
X400	1/2	1075/1	460	48Y	FEH1056SF, 435A				3738
X099	3/4	1075/1	460	48Y	FH1076				3742



Three Phase Commercial Condenser Fan Motors

Where Used Air conditioning and heat pump condensers

Air Over, Rigid Base

MODEL NO.	HP	RPM	VOLTAGE	FRAME	COMPETITOR CROSS REFERENCE				
					AO SMITH/CENTURY	BALDOR	LEESON	US MOTORS	
X513	1	1140	208-230/460	56HZ	H1050A	CFM3156A	111147	1820H	
X523	1 1/2	1140	208-230/460	56HZ	H1051A	CFM3166A	111148	1821H	
X525	2	1140	208-230/460	56HZ	H698	-	-	1822H	



Belly Band, Resilient Mount

MODEL NO.	HP	RPM	VOLTAGE	FRAME	COMPETITOR CROSS REFERENCE					
					AO SMITH/CENTURY	BALDOR	FASCO	LEESON	MAGNETEK	US MOTORS
X502	1	1140	200-230/460	56Y	H1050A	CFM3156A	D6608	-	H667	1818H
X507	1	850	200-230/460	56Y	H1053A	-	-	-	H686	1828V
X503	1 1/2	1140	200-230/460	56Y	H1051A	CFM3166A	D6610	111148	H767	1819H
X530	1 1/2	850	200-230/460	56Y	H1054A	-	-	-	-	1832H
X509	2	1140	200-230/460	56Y	H698	-	-	-	H698	8987V



MARS NO.	MODEL NO.	DESCRIPTION	AO SMITH/CENTURY	COMPETITOR CROSS REFERENCE			
				MAGNETEK	FASCO	EMERSON	BALDOR
X459	048A11T581	3/4HP 460V Ball	FEH1076SF	-	-	-	-

* No reversing plug





Single Phase Fan and Blower Motors

Where Used Medium and large building ventilation systems, commercial kitchen exhaust systems

Split Phase, Dripproof, Resilient Base

MODEL NO.	HP	RPM	VOLTAGE	FRAME	PROTECTION	COMPETITOR CROSS REFERENCE			
						AO SMITH/CENTURY	BALDOR	MAGNETEK	US MOTORS
B302	1/4	1725	115	48YZ	NONE	919L	–	919	D14B2N4Z
B303	1/4	1725	115	48YZ	AUTO	GF2024	RSP1441A	808	3618
B305	1/3	1725	115	48YZ	AUTO	RB2034	–	922	PD6004
4706	1/3	1725	115	48YZ	AUTO	GF2034	RSP2442A	–	8100
B208	1/2	1725	115	48YZ	AUTO	GF2054	RSP3451A	811	8200



Capacitor Start, Dripproof, Resilient Base

MODEL NO.	HP	RPM	VOLTAGE	FRAME	PROTECTION	COMPETITOR CROSS REFERENCE					
						AO SMITH/CENTURY	BALDOR	FASCO	LEESON	MAGNETEK	US MOTORS
B315	1/3	1725	115/208-230	48YZ	AUTO	RBF1034A	–	–	–	–	180
B317	1/2	1725	115/208-230	56	AUTO	C412V1	RL1304A	D6084	100011.00	–	D12CA2JH9
B318	3/4	1725	115/208-230	56	NONE	C666	–	–	100016.00	C666	D34C2J9
B319	3/4	1725	115/208-230	56	AUTO	C426V1	RL1307A	D6086	100012.00	–	1893
C1158	1	1725	115/208-230	56	AUTO	C523V1	RL1310A	D6088	110007.00	–	D1CA2JH9
4688	1	1725	115/208-230	56Z	AUTO	C523V1	RL1310A	D6088	110007.00	–	D1CA2JH9



Direct Drive Fan & Blower, Reversing Plug, Sleeve, 1075/3, OAO

MODEL NO.	MODEL NO.	DESCRIPTION	COMPETITOR CROSS REFERENCE			
			AO SMITH/CENTURY	MAGNETEK	FASCO	EMERSON
X000	048A11OB1798	1/4HP 115V	DL1026	O533	D721	1863
X002	048A11OB1769	1/3HP 115V	DL1036	O532	D727	1864
X004	048A11OB1755	1/2HP 115V	DL1056	O531	D701	1865
X009	048A110787	3/4HP 115V	DL1076	O678	D726	8904



FASCO STOCK REPLACEMENT PRODUCTS

D1127 Multi-Horsepower Commercial Refrigeration Evaporator Motor

Great Truck Stock!

• **Replaces 12 Motor Ratings:**

- | | | |
|------------------|------------------|------------------|
| 1/12 HP 115V CW | 1/15 HP 115V CW | 1/20 HP 115V CW |
| 1/12 HP 115V CCW | 1/15 HP 115V CCW | 1/20 HP 115V CCW |
| 1/12 HP 230V CW | 1/15 HP 230V CW | 1/20 HP 230V CW |
| 1/12 HP 230V CCW | 1/15 HP 230V CCW | 1/20 HP 230V CCW |

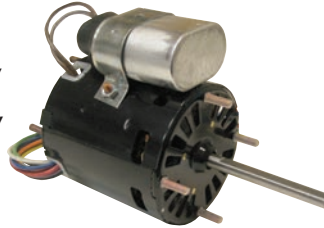

Fasco Motor Quick Facts:

- 3.3" Diameter
- Open Ventilation
- Energy Efficient PSC
- Sleeve Bearing
- Thermally Protected
- UL Recognized
- CSA Certified

- **Reversible**
- **High Efficiency**
Energy-Saving PSC

FASCO MODEL NO.	HP	VOLTS	RPM	AMPS	SWITCH	SPEEDS	SHAFT
D1127	1/12, 1/15, 1/20	115/230	1550	1.1/0.6	No	1	5/16" X 3"

*Can Be Applied In Hundreds Of...
Bohn, Larkin, McQuay, Kramer &
Other OEM Applications*

3.3 Dia. Evaporator Coil & Fan Motors Drop-In Replacements



Sleeve Bearing

FASCO MODEL NO.	TYPE	HP	VOLTS	SPD.	AMPS	ENCLOSURE	ROT.	SHAFT DIM.
BOHN - 1550 RPM								
D1124	SP	1/20	115	1	2.1	Open Ventilated	CW	5/16 X 3
D1126	SP	1/15	230	1	1.1	Open Ventilated	CW	5/16 X 3
D1125	PSC	1/12	208-230	1	0.4	Open Ventilated	CW	5/16 X 2-5/8
LARKIN COIL - 1500 RPM								
D1101	SP	1/20	115	1	1.9	Open Ventilated	CCW	5/16 X 2-1/4
D1103	SP	1/20	208-230	1	1.15	Open Ventilated	CCW	5/16 X 2-1/4

Fan Coil A/C & Heating Unit Motors



Sleeve Bearing

FASCO MODEL NO.	TYPE	HP	VOLTS	RPM	SPD	AMPS	ENCL.	ROT.	SHAFT DIM.
D1050	PSC	1/8	230	1550	1	1.1	Totally Enclosed	CW	1/2 X 3

Draft Inducer Blower Assemblies



FASCO MODEL NO	TYPE	VOLTS	SPD	AMPS	CROSS REFERENCE
A079	SP	115	1	1.1	Rheem Ruud 74-70-21496-03-01, 74-70-21504-03-04 Goodman B1859000, 7021-6804, JA1M106, JA1M137 Trane B1W24, WG94X167
A173	PSC	115	1	0.8	InterCity Products 7062-4785, Alltemp (ROTOM) 7062-4832

**Always use an exact replacement when servicing draft inducer blowers!
See the MARS Catalog - #98605 for complete offering of Fasco Motors**



PSC Direct Drive Blower Motors

Features:

- All angle sleeve bearings
- 1/2 inch extended thru bolts
- 2-1/4 inch resilient rings plus 4 split rings
- 4 inch long, 1/2 inch diameter shaft

Specifications:

- Single phase, 60 Hertz
- Overload protection
- Fan duty, continuous, air over
- Open construction
- 26 inch leads
- Class B insulation

1075 RPM — Reversible Rotation - Standard Efficiency - 6 Pole

MARS NO.	GE NO. 5KCP39	HP	VOLTS	AMPS	CAP REQ.	BASE NO.
Three Speed⁽¹⁾						
03583*	FGN651T	1/4	115	4.2	5/370	08055
03586*	JGN654T	1/3	208-230	2.9	5/370	NA
03587*	PGN655T	1/2	115	9.0	5/370	08060
03588*	NGN656T	1/2	208-230	4.3	5/370	NA
03595*	SGL854S	1	115	11.8	20/370	08060

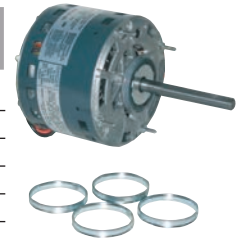

(1) Approximately 150RPM differential between speeds depending on fan load
 * While supplies last

SOS™ Multi-Horsepower Direct Drive Blower Motors

Features:

- Open end shields
- Extended mounting studs
- 2-1/2 inch resilient rings
- Reversible rotation
- All angle sleeve or ball bearings
- Capacitor requirement noted on motor label

Specifications:

- Single phase, 60 Hz
- Overload protection
- Fan duty, continuous air over
- Open construction

1075 RPM Multi-Horsepower Reversible Rotation - 6 Pole

MARS NO.	GE NO. 5KCP39	HP	VOLTS	AMPS
03463*	KGV804AS	1/2, 1/3, 1/4, 1/5, 1/6	115	6.2
03464*	KGV805AS	1/2, 1/3, 1/4, 1/5, 1/6	208-230	2.7
03466 ⁽¹⁾ *	SGU363AS	3/4, 1/2, 1/3, 1/4, 1/5	115	8.4



(1) Ball Bearing
 * While supplies last

SOS™ Multi-Horsepower Outdoor Condenser Fan Motors

Features:

- Ball Bearings
- Thru bolt or band mounting
- Rheem mounting capability
- Water slinger on shaft
- Capacitor requirement noted on motor label
- End Shield drain holes w/plug

Specifications:

- Single phase, 60 Hz
- Overload protection
- Fan duty, continuous air over
- Totally enclosed, Non-ventilated
- Class B insulation

Multi-Horsepower, Reversible Rotation

MARS NO.	GE NO. 5KCP39	HP	VOLTS	AMPS
1075 RPM - 6 Pole				
Wizard 03458*	JGU530S	1/3, 1/4, 1/5, 1/6	208-230	2.80

* While supplies last



Professional Grade

What Makes a Professional Grade Contactor?

1. Enclosed Body
2. Oversized 'Arch Window' Lugs
3. High Performance Copper & Brass Conductors
4. Multi-purpose Coil Terminals with QC Terminals
5. Removable Coils
6. Removable Cover
7. Captive Arc Chutes
8. Thermoplastic Housing

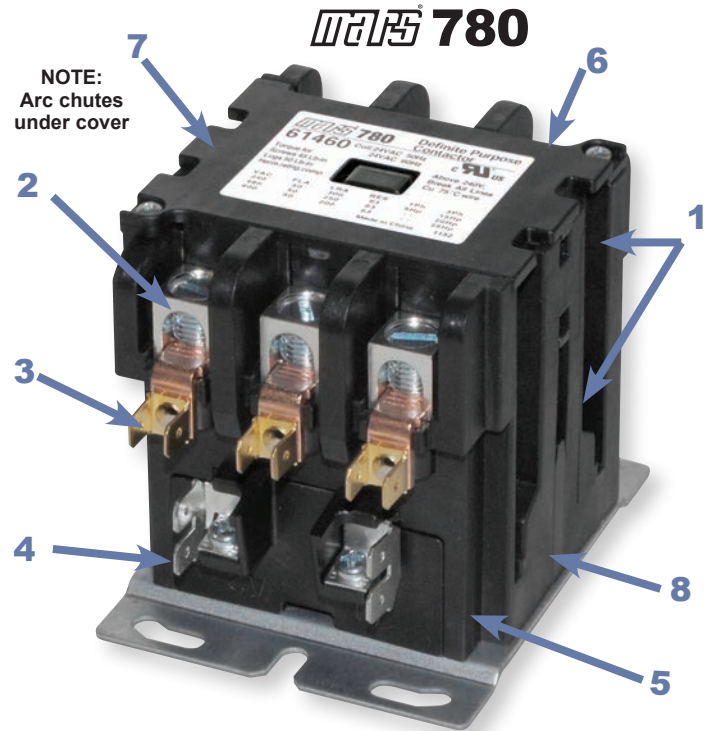

MARS 780 vs. Competition

<p>MARS 780 30A/40A</p>	<p>Competition 30A/40A</p>	<p>MARS 780 2P-40A</p>	<p>Competition 2P-40A</p>
<p>Accessible Coil Terminals</p> <p>Copper Conductors</p> <p>Unobstructed Mounting Holes</p>	<p>Concealed coil terminals</p> <p>Low conductivity steel conductors</p> <p>Obstructed mounting holes</p>		<p>Heat destroys components. Thermal imagery depicts significant heat generation of the steel conductor equipped contactor.</p> <p>Copper conductors provide a cool running MARS 780.</p>

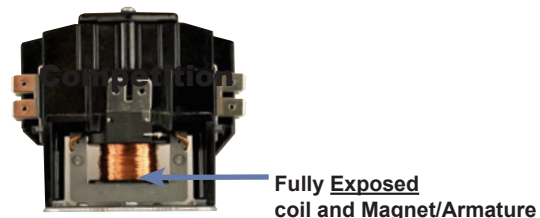
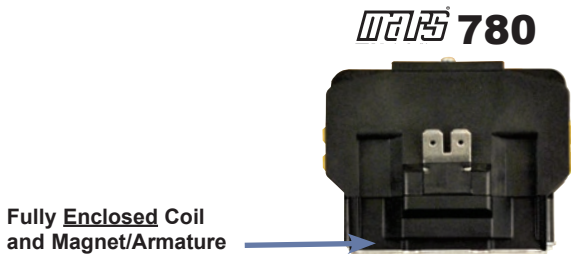

The **MARS** 780 Series



MARS NO.	POLES	FULL LOAD AMPS	COIL VOLTAGE	WIRE TERMINATION
61320	1.5	30	24	Quick Connect & Screw Terminals
61321	1.5	30	120	Quick Connect & Screw Terminals
61322	1.5	30	208-240	Quick Connect & Screw Terminals
61720	1.5	30	24	Quick Connect & Box Lugs
61721	1.5	30	120	Quick Connect & Box Lugs
61722	1.5	30	208-240	Quick Connect & Box Lugs
61730	1.5	40	24	Quick Connect & Box Lugs
61731	1.5	40	120	Quick Connect & Box Lugs
61732	1.5	40	208-240	Quick Connect & Box Lugs
61345	2	30	24	Quick Connect & Screw Terminals
61346	2	30	120	Quick Connect & Screw Terminals
61347	2	30	208-240	Quick Connect & Screw Terminals
61745	2	30	24	Quick Connect & Box Lugs
61746	2	30	120	Quick Connect & Box Lugs
61747	2	30	208-240	Quick Connect & Box Lugs
61755	2	40	24	Quick Connect & Box Lugs
61756	2	40	120	Quick Connect & Box Lugs
61757	2	40	208-240	Quick Connect & Box Lugs
61430	3	30	24	Screw Terminals
61431	3	30	120	Screw Terminals
61432	3	30	208-240	Screw Terminals
61750	3	30	24	Box Lugs
61751	3	30	120	Box Lugs
61752	3	30	208-240	Box Lugs
61445	3	40	24	Box Lugs
61446	3	40	120	Box Lugs
61447	3	40	208-240	Box Lugs
61460	3	50	24	Box Lugs
61461	3	50	120	Box Lugs
61462	3	50	208-240	Box Lugs
61470	3	60	24	Box Lugs
61471	3	60	120	Box Lugs
61472	3	60	208-240	Box Lugs
61480	3	75	24	Box Lugs
61481	3	75	120	Box Lugs
61482	3	75	208-240	Box Lugs
61490	3	90	24	Box Lugs
61491	3	90	120	Box Lugs
61492	3	90	208-240	Box Lugs

MARS 910 Definite Purpose Contactors

MARS definite purpose contactors are available in one pole with shunt (one- and one-half pole, 30 thru 40 amps), 2 pole (30 and 40 amp), and 3 pole (30 through 75 amp) configurations. The universal mounting base allows replacement of most contactor brands. Straight-thru wiring and small size speeds installation.

Features:

- Used in air conditioning, electric heating, and refrigeration systems
- Box lug terminations speed installation
- Universal mounting base
- Contact cover and enclosed coils reduce dirt and insect intrusion
- Compact design
- Silver-Cadmium contacts

Specifications:

- Meets ARI 780/790 requirements
- cULus Approval
- 1,000,000 Cycle mechanical life

MARS 910 contactors are transitioning to an A2L compliant design. Scan for more details.

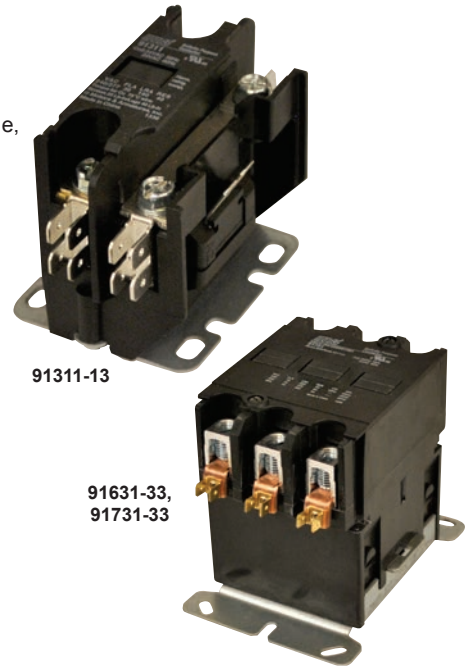

MARS NO.	FLA	POLES	LOCKED ROTOR AMPS				RES. AMPS	COIL VOLTS	TERMINATION	HORSEPOWER			
			240	277	480	600				1 PH 240	240	3 PH 480	600
91311							24						
91312	30	1 Pole w/Shunt	180	180			40	120	Screw Type	-	-	-	-
91313								208/230					
91315							24						
91316	30	1 Pole w/Shunt	180	180			40	120	Box Lug	-	-	-	-
91317								208/230					
91321							24						
91322	30	2	180	-	150	120	40	120	Screw Type	-	-	-	-
91323								208/230					
91325							24						
91326	30	2	180	-	150	120	40	120	Box Lug	-	-	-	-
91327								208/230					
91331							24						
91332	30	3	180	-	150	120	40	120	Screw Type	3 HP	7.5 HP	10 HP	15 HP
91333								208/230					
91335							24						
91336	30	3	180	-	150	120	40	120	Box Lug	3 HP	7.5 HP	10 HP	15 HP
91337								208/230					
91411	40	1 Pole w/Shunt	240	240	-	-	50	24	Box Lug	-	-	-	-
91421							24						
91422	40	2	240	-	200	160	50	120	Box Lug	-	-	-	-
91423								208/230					
91431							24						
91432	40	3	240	-	200	160	50	120	Box Lug	5 HP	10HP	15 HP	20 HP
91433								208/230					
91531							24						
91532	50	3	300	-	250	200	63	120	Box Lug	5 HP	15 HP	20 HP	25 HP
91533								208/230					
91631							24						
91632	60	3	360	-	300	240	75	120	Box Lug	7.5 HP	20 HP	25 HP	30 HP
91633								208/230					
91731							24						
91732	75	3	450	-	375	300	94	120	Box Lug	15 HP	25 HP	40 HP	40 HP
91733								208/230					

JARD Definite Purpose Contactors

JARD Definite Purpose Contactors are designed for use on refrigeration, air conditioning, and electric heating systems. The universal mounting base allows replacement of most contactor brands. Power connections can be made with lugs & quick connects.

- Lug terminals with quick connects •UL •CUL

JARD W/LUGS	POLES	FULL LOAD AMPS	FULL RESISTIVE AMPS	COIL VOLTAGE
17215	1-1/2	25	40	24
17216	1-1/2	25	40	120
17217	1-1/2	25	40	240
17225	2	25	40	24
17226	2	25	40	120
17227	2	25	40	240
17315	1-1/2	30	40	24
17316	1-1/2	30	40	120
17317	1-1/2	30	40	240
17325	2	30	40	24
17326	2	30	40	120
17327	2	30	40	240
17335	3	30	40	24
17336	3	30	40	120
17337	3	30	40	240
17415	1-1/2	40	50	24
17416	1-1/2	40	50	120
17417	1-1/2	40	50	240
17425	2	40	50	24
17426	2	40	50	120
17427	2	40	50	240
17435	3	40	50	24
17436	3	40	50	120
17437	3	40	50	240
17535	3	50	65	24
17536	3	50	65	120
17537	3	50	65	240
17635	3	60	75	24
17636	3	60	75	120
17637	3	60	75	240
17735	3	75	90	24
17736	3	75	90	120
17737	3	75	90	240
17935	3	90	120	24
17936	3	90	120	120
17937	3	90	120	240
17999		Auxiliary Contact - Fits 40A 3P Models		
17998		Auxiliary Contact - Fits 50A & 60A 3P Models		
17997		Auxiliary Contact - Fits 75A & 90A 3P Models		

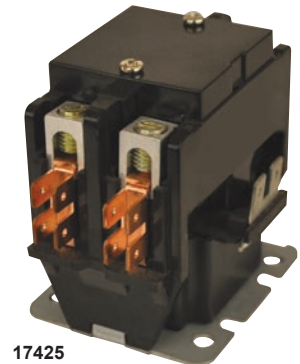



MARS USA Motor Run Capacitors

SINGLE SECTION	
MARS NO.	DESCRIPTION
Oval 370V	
14002	2 MFD 370V OVL
14003	3 MFD 370V OVL
14004	4 MFD 370V OVL
14005	5 MFD 370V OVL
14006	6 MFD 370V OVL
14007	7.5 MFD 370V OVL
14008	10 MFD 370V OVL
14009	12.5 MFD 370V OVL
14010	15 MFD 370V OVL
14012	17.5 MFD 370V OVL
14014	20 MFD 370V OVL
14015	25 MFD 370V OVL
14017	30 MFD 370V OVL
14018	35 MFD 370V OVL
14021	40 MFD 370V OVL
14023	45 MFD 370V OVL
14025	50 MFD 370V OVL
14024	55 MFD 370V OVL
14087	60 MFD 370V OVL
14089	70 MFD 370V OVL
14090	80 MFD 370V OVL

Oval 440/370V	
14026	2 MFD 440/370V OVL
14027	3 MFD 440/370V OVL
14028	4 MFD 440/370V OVL
14029	5 MFD 440/370V OVL
14030	6 MFD 440/370V OVL
14031	7.5 MFD 440/370V OVL
14032	10 MFD 440/370V OVL
14033	12.5 MFD 440/370V OVL
14034	15 MFD 440/370V OVL
14036	17.5 MFD 440/370V OVL
14037	20 MFD 440/370V OVL
14040	25 MFD 440/370V OVL
14041	30 MFD 440/370V OVL
14043	35 MFD 440/370V OVL
14045	40 MFD 440/370V OVL
14048	45 MFD 440/370V OVL
14049	50 MFD 440/370V OVL
14050	55 MFD 440/370V OVL
14051	60 MFD 440/370V OVL
14130	70 MFD 440/370V OVL
14140	80 MFD 440/370V OVL

SINGLE SECTION	
MARS NO.	DESCRIPTION
Round 370V	
14095	5 MFD 370V RND
14098	10 MFD 370V RND
14099	12.5 MFD 370V RND
14210	15 MFD 370V RND
14212	17.5 MFD 370V RND
14214	20 MFD 370V RND
14215	25 MFD 370V RND
14217	30 MFD 370V RND
14218	35 MFD 370V RND
14821	40 MFD 370V RND
14823	45 MFD 370V RND
14225	50 MFD 370V RND
14226	55 MFD 370V RND
14227	60 MFD 370V RND
14128	65 MFD 370V RND
14229	70 MFD 370V RND
14199	80 MFD 370V RND
14116	100 MFD 370V RND

Round 440/370V	
14102	2 MFD 440/370V RND
14103	3 MFD 440/370V RND
14104	4 MFD 440/370V RND
14105	5 MFD 440/370V RND
14106	6 MFD 440/370V RND
14107	7.5 MFD 440/370V RND
14232	10 MFD 440/370V RND
14833	12.5 MFD 440/370V RND
14234	15 MFD 440/370V RND
14237	20 MFD 440/370V RND
14240	25 MFD 440/370V RND
14241	30 MFD 440/370V RND
14243	35 MFD 440/370V RND
14245	40 MFD 440/370V RND
14248	45 MFD 440/370V RND
14251	50 MFD 440/370V RND
14252	55 MFD 440/370V RND
14254	60 MFD 440/370V RND
14256	65 MFD 440/370V RND
14258	70 MFD 440/370V RND
14259	80 MFD 440/370V RND

DUAL SECTION	
MARS NO.	DESCRIPTION
Oval 370V	
14063	20/5 MFD 370V OVL
14066	25/5 MFD 370V OVL
14069	30/5 MFD 370V OVL
14072	35/5 MFD 370V OVL
14171	40/5 MFD 370V OVL
14174	45/5 MFD 370V OVL

Oval 440/370V	
14170	10/10 MFD 440/370V OVL
14184	25/5 MFD 440/370V OVL
14187	30/5 MFD 440/370V OVL
14085	35/3 MFD 440/370V OVL
14185	35/5 MFD 440/370V OVL
14188	35/7.5 MFD 440/370V OVL
14086	40/5 MFD 440/370V OVL
14189	40/7.5 MFD 440/370V OVL
14190	45/5 MFD 440/370V OVL
14274	45/7.5 MFD 440/370V OVL
14275	55/5 MFD 440/370V OVL
14297	80/5 MFD 440/370V OVL
14298	80/7.5 MFD 440/370V OVL

Round 370V	
14260	20/5 MFD 370V RND
14208	20/10 MFD 370V RND
14261	25/5 MFD 370V RND
14213	25/10 MFD 370V RND
14244	30/3 MFD 370V RND
14263	30/4 MFD 370V RND
14082	35/3 MFD 370V RND
14131	35/4 MFD 370V RND
14264	30/5 MFD 370V RND
14266	35/5 MFD 370V RND
14238	35/10 MFD 370V RND
14178	40/5 MFD 370V RND
14268	40/7.5 MFD 370V RND
14246	40/10 MFD 370V RND
14073	45/3 MFD 370V RND
14269	45/5 MFD 370V RND
14249	45/7.5 MFD 370V RND
14250	45/10 MFD 370V RND
14075	50/3 MFD 370V RND
14191	50/5 MFD 370V RND
14192	50/7.5 MFD 370V RND
14239	50/10 MFD 370V RND
14193	55/5 MFD 370V RND
14194	55/7.5 MFD 370V RND
14195	60/5 MFD 370V RND
14196	60/7.5 MFD 370V RND
14265	60/10 MFD 370V RND
14042	65/5 MFD 370V RND
14053	70/5- MFD 370V RND
14054	70/7.5 MFD 370V RND
14197	80/5 MFD 370V RND
14198	80/7.5 MFD 370V RND
14201	80/10 MFD 370V RND

DUAL SECTION	
MARS NO.	DESCRIPTION
Round 440/370V	
14115	20/5 MFD 440/370V RND
14353	25/3 MFD 440/370V RND
14278	25/5 MFD 440/370V RND
14279	25/7.5 MFD 440/370V RND
14113	25/10 MFD 440/370V RND
14126	30/3 MFD 440/370V RND
14281	30/5 MFD 440/370V RND
14282	30/7.5 MFD 440/370V RND
14352	30/10 MFD 440/370V RND
14077	35/3 MFD 440/370V RND
14070	35/4 MFD 440/370V RND
14283	35/5 MFD 440/370V RND
14284	35/7.5 MFD 440/370V RND
14091	35/10 MFD 440/370V RND
14078	40/3 MFD 440/370V RND
14286	40/5 MFD 440/370V RND
14287	40/7.5 MFD 440/370V RND
14088	40/10 MFD 440/370V RND
14079	45/3 MFD 440/370V RND
14288	45/5 MFD 440/370V RND
14289	45/7.5 MFD 440/370V RND
14172	45/10 MFD 440/370V RND
14290	50/5 MFD 440/370V RND
14291	50/7.5 MFD 440/370V RND
14124	50/10 MFD 440/370V RND
14299	55/10 MFD 440/370V RND
14292	55/5 MFD 440/370V RND
14293	55/7.5 MFD 440/370V RND
14294	60/5 MFD 440/370V RND
14295	60/7.5 MFD 440/370V RND
14296	60/10 MFD 440/370V RND
14358	65/5 MFD 440/370V RND
14359	65/7.5 MFD 440/370V RND
14162	65/10 MFD 440/370V RND
14255	70/5 MFD 440/370V RND
14166	70/7.5 MFD 440/370V RND
14169	70/10 MFD 440/370V RND
14168	75/5 MFD 440/370V RND
14125	75/7.5 MFD 440/370V RND
14027	75/10 MFD 440/370V RND
14257	80/5 MFD 440/370V RND
14216	80/7.5 MFD 440/370V RND
14117	80/10 MFD 440/370V RND



WARNING:
Cancer and Reproductive Harm
www.P65Warnings.ca.gov

Toll Free (800) 445-4155 • Fax (631) 348-7160
www.marsdelivers.com



The Turbo Family of Products

Have The Right Capacitor and Hardstart For The Job... Every Time.
Perfect Solution For Off Hour Emergency Service Calls.



Scan for video.

Made in the USA

Made with Premium Components

Includes CPT®

CPT® on 12200 and 12300 protects compressor in event of a capacitor failure. CPT® Fuse Wire on 12600 and 12700 protects compressor in the event of a relay failure.

MARS NO.	DESCRIPTION	MICROFARAD	VOLTAGE	WARRANTY
12100	Turbo 200® Mini	2.5 MFD - 15 MFD	370V or 440V	5 years
12500	Turbo 200® Mini - Oval	2.5 MFD - 15 MFD	370V or 440V	5 years
12200	Turbo 200® with CPT®	2.5 MFD - 67.5 MFD	370V or 440V	5 years
12300	Turbo 200®X with CPT®	5.0 MFD - 97.5 MFD	370V or 440V	5 years
11200*	Turbolytic® 50	23 MFD - 302 MFD	125V to 330V	5 years
11100*	Turbolytic® JR	23 MFD - 208 MFD	125V to 330V	5 years
12600	Turbo Easy-Start® 5 with CPT® Fuse Wire	Up to 1 ton 108 - 130 MFD 1 to 2 tons 189 - 227 MFD 2.5 to 3 tons 233 - 280 MFD 3.5 to 5 tons 270 - 324 MFD	Up to 330V	5 years
12700**	Turbo Easy-Start® 5 EXT with External Potential Relay and CPT® Fuse Wire	Up to 1 ton 108 - 130 MFD 1 to 2 tons 189 - 227 MFD 2.5 to 3 tons 233 - 280 MFD 3.5 to 5 tons 270 - 324 MFD	Up to 330V	3 years

* New smaller can size

** New Turbo® product



Toll Free (800) 445-4155 • Fax (631) 348-7160
www.marsdelivers.com

WARNING:
Cancer and Reproductive Harm
www.P65Warnings.ca.gov

MARS Fan Control Centers

Features:

- Choice of SPST, SPDT, SPNO / SPNC or DPDT relay switching options
- UL 1585 40 VA transformer
- Color coded leads
- Low voltage terminal board
- Mounts directly to 4" electrical box
- Made in USA



40VA 3/4 hp

MARS NO.	TRANSFORMER				RELAY	CONTACT RATINGS			
	PRIMARY		SECONDARY			120V AC (AMPS)		240V AC (AMPS)	
	VOLTAGE	CONNECTIONS	VOLTAGE	CONNECTIONS		FULL LOAD	LOCKED ROTOR	FULL LOAD	LOCKED ROTOR
24010	120/208/240	Color coded leads, pre-stripped	24V	Terminal board with 5 screw terminals	DPDT	13.8	82.8	6.9	41.4
24012	120	Color coded leads, pre-stripped	24V	Terminal board with 5 screw terminals	SPNO/SPNC	13.8	82.8	6.9	41.4
24013	120	Color coded leads, pre-stripped	24V	Terminal board with 5 screw terminals	SPDT	13.8	82.8	6.9	41.4

JARD General Purpose Switching Relays

SPST and SPDT fan relays are among the most popular relays used in air conditioning today.

JARD NO.	NORMALLY OPEN COIL VOLTAGE	CONTACT RATING 125/250 VAC	
		INDUCTIVE	RESISTIVE
SPST			
92290	24	8 amps	16 amps
92291	110-120	continuous	16 amps
92292	208/240	25 amps inrush	16 amps
SPDT			
92293	24	8 amps	16 amps
92294	110-120	continuous	16 amps
92295	208/240	25 amps inrush	16 amps



25 Amp Switching Relays - 120V Contact Rating

JARD NO.	DESCRIPTION	COIL VOLTAGE
92360	SPST-NO	24
92370	SPDT	24
92380	SPNO-SPNC	24

2PDT HVAC Relays

JARD NO.	COIL VOLTAGE
92340	24
92341	110/120
92342	208/240

Help Homeowners Protect Their Equipment

MARS Side Open Disconnect Boxes with Internal Surge Protection Fused and Non-Fused

MARS Disconnects with integrated surge protector provide a unitized design for quick and clean installation. The metal weather-resistant enclosure provides additional robustness and security. MARS Surge Protectors provide the performance necessary to protect critical components in high efficiency mini-split and unitary HVAC equipment.

Features:

- Integrated internal surge protector
- Metal-weather resistant enclosure
- External LED status indicator
- 3 Year warranty
- \$7500 Connected equipment warranty

Protects:

- Motors
- Compressors
- Control Boards
- Sensors
- Reversing valves
- Inverter Boards

No. 83910 Surge Protector:

- Type 1 or 2 SPD
- UL 1449 4th Edition
- 120/240 Split phase 50/60Hz
- Nominal discharge (In): 10kA
- SCCR 22kA
- Max continuous overvoltage: (MCOV) L-G 150V / L-L 300V
- Voltage protection rating: (VPR) L-G 700V / L-L 1200V



MARS NO.	DESCRIPTION	ENCLOSURE	INCLUDES SURGE PROTECTOR
83915	60 Amp Non-Fused w/Surge Module	NEMA 3R, Rainproof	MARS No. 83910
83916	30 Amp Fused w/Surge Module	NEMA 3R, Rainproof	MARS No. 83910
83917	60 Amp Fused w/Surge Module	NEMA 3R, Rainproof	MARS No. 83910

MARS NO.	DESCRIPTION
83910	Replacement Surge Module For 83915, 83916 and 83917



MARS Surge Protective devices utilize Thermally Protective MOV surge technology



Toll Free (800) 445-4155 • Fax (631) 348-7160
www.marsdelivers.com

WARNING:
Cancer and Reproductive Harm
www.P65Warnings.ca.gov

208-230/240V MARS HVAC Surge Protective Device

Designed To Protect Outdoor and Indoor HVAC Equipment

The MARS SPD is designed to protect your HVAC equipment from power spikes, surges and transients. The MARS SPD utilizes Thermally Protected MOV technology to provide safe and reliable surge protection.

Protects:

- Compressors
- Heat Pumps
- Ideal for Ductless Systems
- Inverter Boards
- ECM Motors
- Control Boards
- Transformers
- Relays
- Sensors

Features:

- Easy Installation to Disconnect
- Weatherproof 4X Enclosure
- 18" Pre-stripped Leads
- Green & Red LED Status Indicators
- Thermally Protected MOVs
- 120/240V Single (Split) Phase 50/60Hz
- Short Circuit Current Rating
 - 22,000 Amps
- MCOV L-G 150V / L-L 300V
- Voltage Protection Rating
 - L-G 700V / L-L 1200V
- UL 1449 4th Edition
- Type 1 or 2 Surge Protection Rating
- 3 Year Warranty
- \$7,500 Connected Equipment Warranty



MARS Surge Protective devices utilize Thermally Protective MOV surge technology

Specifications

MARS NO.	VOLTAGE	WIRE CONFIGURATION	SPD TYPE	MCOV	ENCL	UL 1449 4TH EDITION
83905	120/240	L-L, L-G	1 or 2	150/300	Type 4X	cULus

120V MARS HVAC Surge Protective Device

For Furnace Air Handlers and 120V Ductless Equipment

The MARS 83904 SPD is designed specifically for 120V furnace and air handler applications. The 120V Surge Device is easy to install with only 2 wires to connect. The MARS SPD utilizes thermally protected MOV technology for safe and reliable protection of equipment.

Protects:

- Ideal for 120V Ductless Systems
- Furnace & Air Handlers
- Inverter Boards
- ECM Motors
- Control Boards
- Transformers
- Relays
- Sensors

Features:

- Easy 2 Wire Installation
- 10" Pre-stripped Leads
- Green LED Status Indicator
- Thermally Protected MOVs
- 120V Single Phase 50/60Hz
- Short Circuit Current Rating
 - 10,000 Amps
- MCOV L-G 150V
- Voltage Protection Rating
 - L-G 700V
- UL 1449 4th Edition
- Type 1 or 2 Surge Protection Rating
- 3 Year Warranty
- \$7,500 Connected Equipment Warranty



MARS Surge Protective devices utilize Thermally Protective MOV surge technology

Specifications

MARS NO.	VOLTAGE	WIRE CONFIGURATION	SPD TYPE	MCOV	ENCL	UL 1449 4TH EDITION
83904	120	L-G	1 or 2	150	Type 2	cULus

MARS Intelligent Surge Protective Device For Unitary Equipment

The **ISPD** (*Intelligent Surge Protection Device*) offers comprehensive protection for your HVAC equipment.

The MARS 83907 Surge Protection Device is designed to provide maximum compressor protection from harmful power surges, transients and over-voltages utilizing the latest Thermally Protected MOV technology.

In the event of diminished surge protection or failure, the compressor will not be allowed to start until the module is replaced.

Protects the Following Equipment and Components:

- Compressors
- Heat Pumps
- Control & Defrost Boards
- Reversing Valves
- Sensors & Relays
- ECM Motors
- Transformers

Plus:

- Low Voltage Protection
- Coil Freeze-up / Low Refrigerant Detection
- Short Cycle Guard

Features:

- Easy installation to disconnect box
- Weatherproof 4X enclosure
- Fits 1/2" knockouts
- Green & Red LED status indicators
- Thermally protected MOVs
- 240V single phase 50/60Hz
- Max surge current 10,000 A
- Max continuous over voltage L-G 150V / L-L 300V
- Voltage protection rating L-G 700V / L-L 1200V
- **3 Year warranty**
- **\$7,500 Connected equipment warranty**



240 VAC Single Split Phase SPD for use on HVAC Equipment

Microprocessor Based Controls



LED Status Indicators

18 in. 10 Gauge Leads

1/2 inch x 20 Threaded Nipple



Meets all UL 1449 4th Edition Standards

Unmatched Surge Protection Ratings
Type 4x Weatherproof Enclosure UV Resistant

MARS NO.	VOLTAGE	WIRE CONFIGURATION	SPD TYPE	MCOV	ENCL	UL 1449 4TH EDITION
83907	240	L-L, L-G	1 or 2	150/300	Type 4X	cULus

MARS Surge Protective devices utilize Thermally Protective MOV surge technology

The Most Powerful Pump

MARS Condensate Pump Features & Benefits

STAINLESS STEEL COMPONENTS – Resists Rust & Corrosion

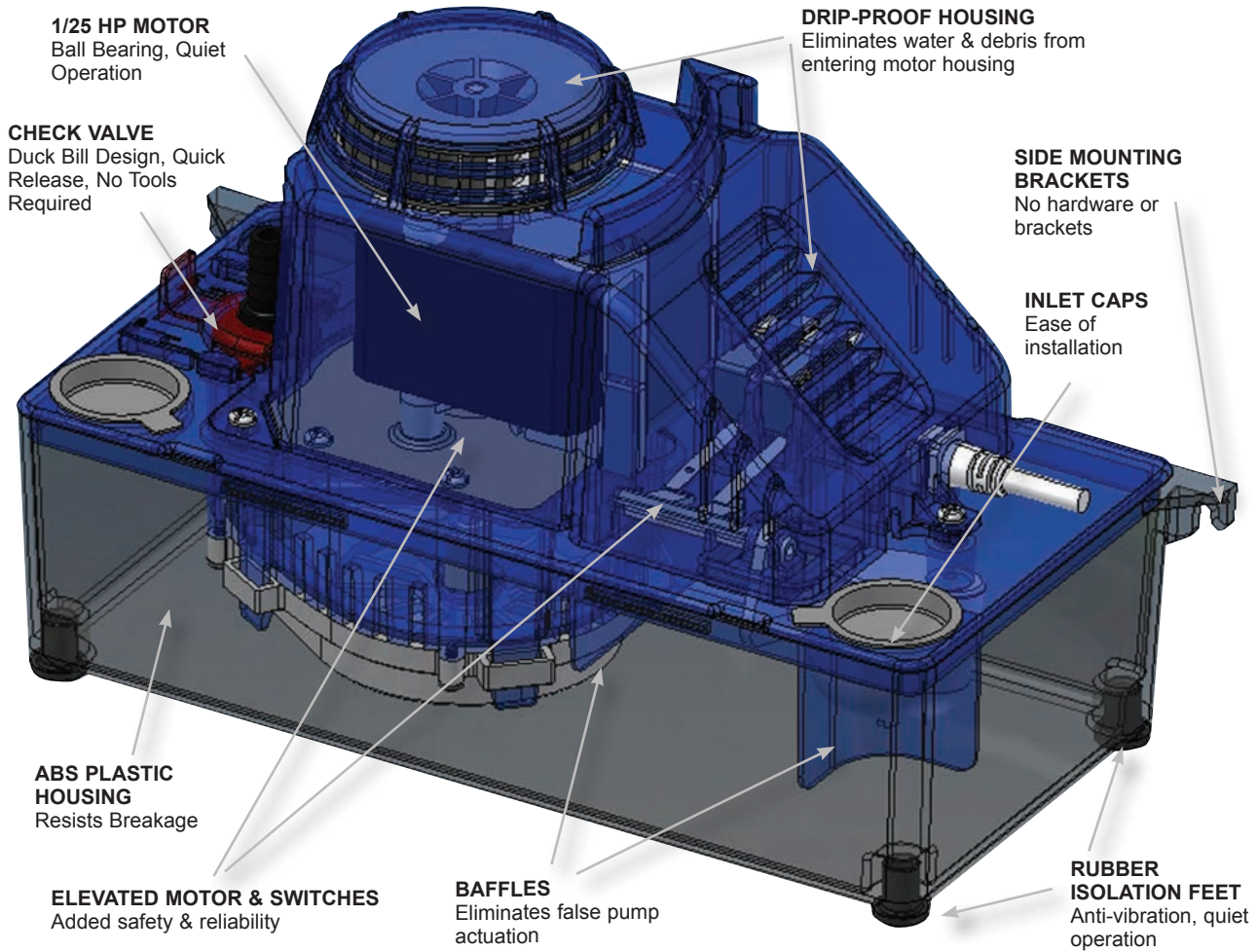

1/25 HP MOTOR
Ball Bearing, Quiet Operation

DRIP-PROOF HOUSING
Eliminates water & debris from entering motor housing

CHECK VALVE
Duck Bill Design, Quick Release, No Tools Required

SIDE MOUNTING BRACKETS
No hardware or brackets

INLET CAPS
Ease of installation

ABS PLASTIC HOUSING
Resists Breakage

ELEVATED MOTOR & SWITCHES
Added safety & reliability

BAFFLES
Eliminates false pump actuation

RUBBER ISOLATION FEET
Anti-vibration, quiet operation

24' Lift Pump

MARS NO.	DESCRIPTION
21780	115 V, 60 Hz, 0.91 Amps, 71 Watts 6' Cord, 3/8" Check Valve, Safety Switch Medium Reservoir
21781	115 V, 60 Hz, 0.91 Amps, 71 Watts 6' Cord, 3/8" Check Valve, Safety Switch 20' Tubing, Medium Reservoir
21782	230 V, 60 Hz, 0.6 Amps, 75 Watts 6' Cord, 3/8" Check Valve, Safety Switch Medium Reservoir
21783	230 V, 60 Hz, 0.6 Amps, 75 Watts 6' Cord, 3/8" Check Valve, Safety Switch 20' Tubing, Medium Reservoir

Check Valve Replacement

MARS NO.	DESCRIPTION
21787	Check Valve Replacement

Low Profile 22' Pump

MARS NO.	DESCRIPTION
21784	115 V, 60 Hz, 1.07 Amps, 67 Watts, Low Profile, 22' Lift 6' Cord, 3/8" Check Valve, Safety Switch Medium Reservoir
21785	230 V, 60 Hz, 0.53 Amps, 68 Watts, Low Profile, 22' Lift 6' Cord, 3/8" Check Valve, Safety Switch Medium Reservoir

16' Lift Pump

MARS NO.	DESCRIPTION
21786	115 V, 60 Hz, 0.75 Amps, 49 Watts, 16' Lift 6' Cord, 3/8" Check Valve, Safety Switch Medium Reservoir

MARS Corrugated Condensate Drain Line

MARS NO.	DESCRIPTION	MARS PACK
79127	5/8" Diameter x 20 ft long, Condensate Drain Line	1

Gotec Tattoo 10 Mini-Split Condensate Pump

With an ultra-quiet 16.4 dB sound rating, the Gotec Tattoo 10 mini-split condensate pumps are the quietest mini-split pumps available. Their small size permits easy installation in an evaporator, above the unit in the ceiling, or in the line-set cover.

Kit Includes – Pump, detection unit, connection tube, mounting plate, and mounting accessories.

Features & Benefits:

- Quietest mini-split pump available (16.4 dB)
- Silent operation (16.4 dB)
- 26 Ft lift
- 2.6 gal/h capacity
- Alarm (NO/NC 8A 230V)
- For use in systems up to 24,000 BTUs
- Designed and manufactured in Switzerland



MARS NO.	VOLTAGE	MODEL	SOUND LEVEL	MAX FLOW	PUMP DIMENSIONS	DETECTION UNIT DIMENSIONS (IN.)
21795*	110	Tattoo 10	16.4 dB	2.6 gal/h	5.9 x 2.1 x 1.1	3.2 x 1.5 x 1.5
21796*	230					

*Early 2024 Availability

MARS Condensate Overflow Switches



MARS 21792 Designed for Auxiliary Drain Pans

- Prevents Condensate Overflow Damage Due to Clogged Drain Lines
- UL Listed
- Switch is Height Adjustable
- Easy Clip - Stainless Steel Bracket
- Switch Components are Sealed for Reliability
- 6' 18 AWG Lead Wires for Ease of Installation
- Replaces SS3
- Bracket Flood Prevention Switch

Cross Reference

MARS NO.	Rectorseal	Diversitech
21792	SS3	CS-3
21793	SS1	CS-1
21794	SS2	CS-2



MARS 21793 T - Fitting Designed for Primary or Auxiliary Drain Lines

- Prevents Condensate Overflow Damage Due to Clogged Drain Lines
- UL Listed
- Kit Includes Standard Tee and Elbow
- Also Includes 3/4" Adapter and Plug Fitting
- Float Cap is Easily Removed for Service / Clean-out
- 6' 18 AWG Lead Wires for Ease of Installation
- Sealed Switch for Reliability
- O-ring on float switch port provides leak-proof seal
- Replaces SS1
- Tee Flood Prevention Switch



MARS 21794 L - Fitting Designed for Primary Pan - Auxiliary Outlet

- Prevents Condensate Overflow Damage Due to Clogged Drain Lines
- UL Listed
- Kit Includes Elbow or L Fitting
- Float Cap is Easily Removed for Service / Clean-out
- 6' 18 AWG Lead Wires for Ease of Installation
- Sealed Switch for Reliability
- O-ring on float switch port provides leak-proof seal
- Replaces SS2
- Elbow Flood Prevention Switch



2 and 3 Wire Hard Start Kits

MARS Hard Start kits Provide the Additional Starting Torque to Help Overcome Compressor Start-up Issues Due to Higher Head Pressures In New HVAC Systems

Two and Three Wire Hard Start Kits feature North American made capacitor and relay which deliver the performance and reliability you have come to expect. Compressor start times are reduced by 30%. Hard Start kits help compressors start quicker to minimize compressor winding overloads that can contaminate refrigerants and cause premature failures.

Features:

- North American Start Capacitor and Relay
- Designed for 208-230/240 Volt applications
- 2 and 3 Wire design for maximum performance
- Reduces start time by 30%
- Extends life of compressor
- Kits include mounting hardware

Cross Reference

MARS NO.	5-2-1 (CPS)	Supco	KickStart	Packard (2 wire)	Diversitech (2 wire)
32713	-	-	TO-5	TQS1	HSK5
32714	-	-	KS-1	TQS2	HSK1
32715	CSR U1	3W1	-	TQS1	HSK5
32716	CSR U2	3W2	-	TQS2	HSK1
32717	CSR U3	3W3	-	-	-

MARS NO.	VOLTS	DESCRIPTION
2 WIRE HARD START KITS		
32713	208-230/240	Max Torque 1 to 3 Ton
32714	208-230/240	Max Torque 3.5 to 5 Ton
3 WIRE HARD START KITS		
32715	208-230/240	Max Torque 1-2-3 Ton
32716	208-230/240	Max Torque 3.5 to 5 Ton
32717	208-230/240	Max Torque 4 to 5 Ton



MARS 3 Wire Hard Start Kits

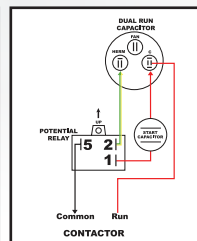
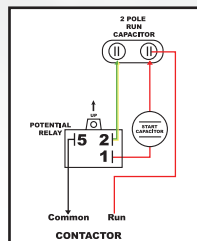

MARS 2 Wire Hard Start Kits

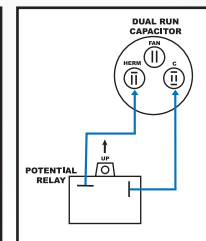
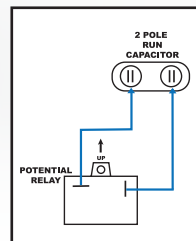

Filter Driers



JARD Filter Drier Family

JARD filter driers are designed and manufactured to ensure effective system protection at an affordable price. JARD driers are available as standard liquid line driers, bi-flow liquid line driers for heat pumps, and suction line driers.

Features:

- Solid core design
- Mixture of activated alumina and molecular sieve ensure adequate moisture and acid removal capacity
- 20 micron filter
- Solid copper ODF connectors
- Approved refrigerants include R-134a, R-12, R-22, R-140a, R-407C, R-404a, R-507, R-502, R-410A, R-1234yf, R-290, R-448A, R-417A, R-422A
- Durable powder coated paint exceeds 500 hour salt spray testing
- UL Listed



JARD Liquid Line Filter Driers

The JARD JLD family of Filter Driers are designed for use in the liquid line of standard refrigeration and air conditioning systems.



MARS No.	Type	Connection (in.)	Flow Capacity (Tons)			Core Size (cu in.)	Dimensions (in)			MWP (psig)
			R-22	R-407C	R-410A		A	B	C	
28120	JLD083	3/8 SAE	6.0	6.0	6.0	8	6.22	3.98	2.13	680
28121	JLD083S	3/8 ODF	6.0	6.0	6.0	8	5.45	3.98	2.13	680
28122	JLD084S	1/2 ODF	8.0	8.0	8.0	8	5.51	3.98	2.13	680
28123	JLD163	3/8 SAE	6.5	6.5	6.5	16	6.85	4.8	3.00	680
28124	JLD163S	3/8 ODF	6.5	6.5	6.5	16	6.24	4.8	3.00	680
28125	JLD164	1/2 SAE	9.0	9.0	9.0	16	7.00	4.8	3.00	680
28126	JLD164S	1/2 ODF	9.0	9.0	9.0	16	6.30	4.8	3.00	680
28127	JLD165S	5/8 ODF	13.5	13.5	13.5	16	6.56	4.8	3.00	680

JARD Bi-flow Filter Driers

JARD JBF filter driers feature an integrated check valve to permit flow in both directions. They are intended for use in reversible heat pump applications.



MARS No.	Type	Connection (in.)	Flow Capacity (Tons)			Core Size (cu in.)	Dimensions (in)			MWP (psig)
			R-22	R-407C	R-410A		A	B	C	
28140	JBF083S	3/8 ODF	5.1	5.0	5.1	8	5.31	4.29	2.50	680
28141	JBF163S	3/8 ODF	5.2	5.1	5.2	16	6.13	4.67	3.00	680
28142	JBF164S	1/2 ODF	8.1	7.9	8.1	16	6.13	4.74	3.00	680

JARD Suction Line Filter Driers

JARD JSD filter driers are designed to be installed in the suction line after a burnout. They feature a wide diameter design to minimize pressure drop and dual access ports to easily gauge pressure difference.



MARS No.	Type	Connection (in.)	Flow Capacity (Tons)			Core Size (cu in.)	Dimensions (in)			MWP (psig)
			R-22	R-407C	R-410A		A	B	C	
28160	JSD13-5S	5/8 ODF	5.0	4.9	6.2	13	5.20	3.45	4.00	680
28161	JSD13-6S	3/4 ODF	7.0	6.8	8.7	13	5.28	3.45	4.00	680
28162	JSD13-7S	7/8 ODF	7.0	6.8	8.7	13	5.51	3.47	4.00	680
28164	JSD27-7S	7/8 ODF	10.0	9.7	12.0	27	7.32	5.47	4.00	680

MARS Universal Heat Pump and Air Conditioning TXV Kit

With a product range of 1 ½ to 5 tons in both R-22/R-407C and R-410A, the MARS Universal AC/HP TXV Kit ensures that supply houses and contractors will always have the TXV they need on hand. This kit includes Danfoss' market leading TR6 expansion valve and all necessary accessories to ensure a fast, easy installation. The most common uses of this valve are as a replacement for a failed valve, as an efficiency upgrade on a system using a piston metering device, or to ensure proper system function when replacing a condensing unit but continuing to use an existing evaporator coil.

Features & Benefits:

- Balance port TXV to ensure proper function in higher capacity systems.
- Built-in check valve enables use with heat pumps.
- Robust stainless steel capillary tube and sensing bulb.
- Includes fittings to ensure easy fit with systems made by any manufacturer.
- Includes valve, all necessary evaporator fittings, tee for both 3/4" and 7/8" equalization connections, foam insulating tape, and bulb strap.



REFRIGERANT	SYSTEM CAPACITY (TONS)*	3/8" ODF CONNECTION	INCLUDED FITTINGS				PART NO.
			AEROQUIP	CHATLEFF	3/8 FLARE	3/4" & 7/8" EQUALIZATION TEES	
R410A	1 ½ - 3	Yes	Yes	Yes	Yes	Yes	72001
	3 ½ - 4	Yes	Yes	Yes	Yes	Yes	72002
	4 ½ - 5	Yes	Yes	Yes	Yes	Yes	72003
R22/R407C	1 ½ - 2	Yes	Yes	Yes	Yes	Yes	72004
	2 ½ - 3	Yes	Yes	Yes	Yes	Yes	72005
	3 ½ - 4	Yes	Yes	Yes	Yes	Yes	72006
	5 - 6	Yes	Yes	Yes	Yes	Yes	72007

MARS Thermocouples

- High temperature stainless steel element for long life and dependable operation.
- Includes adapter fittings for replacing any thermocouple in the field.
- Individually packaged.

MARS NO.	LENGTH
72218	18"
72224	24"
72230	30"
72236	36"
72248	48"

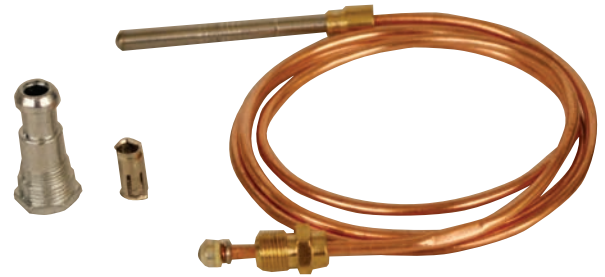

Restring Kits

Older heating elements are no longer available, your only option is to repair them using a properly sized restring kit. MARS Replacement coil kits for electric heat lets you repair strip heaters quickly and economically. MARS restringing kits can be used to repair burnt out heating elements in Electric Furnaces and Heat Pump Air Handler Heating Assemblies. Each kit contains one close wound, stretch to length, resistance coil with welded terminal bolts; two each male and female ceramic terminal insulators; two each .375 and .450 inch standard ceramic bushings; two each .375 and .450 inch extra long ceramic bushings; necessary nuts, washers, and installation instructions.

Features:

- Welded terminal bolts for low resistance and long life
- Close wound coil, stretch to fit many applications
- Complete with bushings, insulators and hardware



Replacement Coil Economy Kits

MARS No.	Description
34600	5000 Watt @ 240V; includes coil, insulators & hardware
34601	5000 Watt @ 240V; includes 300° fuse link, coil, insulators & hardware

MARS NO.	WATTAGE AT				STRETCHED LENGTH			
	240V	208V	480V	277V	INCHES		METERS	
					MIN	MAX	MIN	MAX
34602	5000	3750	—	—	44.62	127.48	1.13	3.24
34604	—	—	5000	—	61.78	176.53	1.57	4.48
34606	—	—	—	5000	59.44	169.82	1.51	4.31
34608	3500	2625	—	—	50.75	145.00	1.29	3.68
34610	—	—	3500	—	42.27	120.76	1.07	3.07
34614	2000	1500	—	—	25.90	74.01	0.66	1.88
34616	2500	1875	—	—	30.89	88.26	0.78	2.24
34620	—	—	—	2500	27.61	78.87	0.70	2.00
34622	1500	1125	—	—	17.04	48.69	0.43	1.24
34624	4500	3375	—	—	42.33	120.95	1.07	3.07
34626	—	—	4500	—	46.05	131.98	1.17	3.35
34630	—	—	2000	—	40.12	114.64	1.02	2.91
34652	6600	4950	—	—	70.56	201.59	1.79	5.12
34654	—	—	6600	—	65.39	186.71	1.66	4.74
34656	6000	4500	—	—	54.43	155.50	1.38	3.95
34658	—	—	6000	—	71.88	205.38	1.83	5.22
34660 ¹	5000	3756	—	—	25.00	70.00	—	—

(1) Larger diameter coil - 5/8"

Low Pressure Controls

Features:

- Tamper proof construction
- Direct mounting on tubing

Specifications:

- Contacts rated at 6 amps, 24-240 volts
- 1/4" female flare S.A.E. mounting
- 18" leads
- UL & CSA recognized



Low Pressure Controls, Open on Pressure Fall, Automatic Reset, Normally Open

JARD NO.	DESCRIPTION	OPENING PRESSURE	RESET PRESSURE
43941	5/20 LP Open on fall	5	20
43942	5/30 LP Open on fall	5	30
43943	10/25 LP Open on fall	10	25
43944	15/35 LP Open on fall	15	35
43945	20/45 LP Open on fall	20	45
43946	25/50 LP Open on fall	25	50
43947	25/65 LP Open on fall	25	65
43948	25/80 LP Open on fall	25	80
43949	35/60 LP Open on fall	35	60
43950	40/80 LP Open on fall	40	80
43951	45/60 LP Open on fall	45	60
43952	50/90 LP Open on fall	50	90
43953	75/100 LP Open on fall	75	100
43975	90/120 LP Open on fall	90	120
43954	150/225 LP Open on fall	150	225
43955	170/225 LP Open on fall	170	225

Fixed Setting Pressure Controls High Pressure Cut-Outs

JARD offers the most complete line of high pressure cut-outs available.

Features:

- Tamper proof construction
- Direct mounting on tubing

Specifications:

- Contacts rated at 6 amps, 24-240 volts
- 1/4" female flare S.A.E. mounting
- 18" leads
- UL & CSA recognized



High Pressure Cut-Outs, Open on Pressure Rise, Automatic Reset, Normally Closed

JARD NO.	DESCRIPTION	OPENING PRESSURE	RESET PRESSURE
43922	250/150 HP Open on rise	250	150
43924	275/195 HP Open on rise	275	195
43925	300/200 HP Open on rise	300	200
43926	325/225 HP Open on rise	325	225
43920	350/245 HP Open on rise	350	245
43927	350/250 HP Open on rise	350	250
43928	375/275 HP Open on rise	375	275
43929	400/200 HP Open on rise	400	200
43930	400/280 HP Open on rise	400	280
43931	400/300 HP Open on rise	400	300
43911	410/290 HP Open on rise	410	290
43932	425/300 HP Open on rise	425	300
43933	425/325 HP Open on rise	425	325
43934	450/250 HP Open on rise	450	250
43965	590/418 HP Open on rise	590	418
43935	600/475 HP Open on rise	600	475
43939	630/480 HP Open on rise	630	480

Condenser Fan Cycling Switch

Manual Reset high pressure controls

Specifications:

- UL & CSA recognized
- 1/4" female flare S.A.E. mounting



JARD NO.	DESCRIPTION	OPENING PRESSURE	RESET PRESSURE	SWITCH ACTION (OPEN ON PRESSURE)
43901	75/100 FC Close on rise	75	100	Fall
43902	110/170 FC Close on rise	110	170	Fall
43903	125/265 FC Close on rise	125	265	Fall
43904	150/225 FC Close on rise	150	225	Fall
43970	180/240 FC Close on rise	180	240	Fall
43905	19/275 FC Close on rise	190	275	Fall
43906	210/275 FC Close on rise	210	275	Fall
43907	300/400 FC Close on rise	300	400	Fall
43912	375/Man. Open on rise	375	Manual	Rise
43913	410/Man. Open on rise	410	Manual	Rise
43916	475/Man. Open on rise	475	Manual	Rise

MARS Complete Line of Pressure Switches Replacement for **Klixon** Pressure Switches



- Appropriate for a wide variety of HVAC/R, commercial, and industrial applications
- Models designed for use in R410A applications

Low Pressure Cut-Out - Open On Pressure Drop

MARS NO.	CUT OUT	CUT IN	NOTES
43341	5	20	1/4" Female Flare S.A.E. Mounting
43342	5	30	1/4" Female Flare S.A.E. Mounting
43343	10	25	1/4" Female Flare S.A.E. Mounting
43344	15	35	1/4" Female Flare S.A.E. Mounting
43345	20	45	1/4" Female Flare S.A.E. Mounting
43372	22	50	1/4" Copper Clad SS Tube w/38" leads
43373	25	40	Gold Contacts 1/4" Female Flare w/36" leads
43346	25	50	1/4" Female Flare S.A.E. Mounting
43347	25	65	1/4" Female Flare S.A.E. Mounting
43348	25	80	1/4" Female Flare S.A.E. Mounting
43349	35	60	1/4" Female Flare S.A.E. Mounting
43350	40	80	1/4" Female Flare S.A.E. Mounting
43351	45	60	1/4" Female Flare S.A.E. Mounting
43352	50	90	1/4" Female Flare S.A.E. Mounting
43374	50	95	1/4" Copper Clad SS Tube w/36" leads
43353	75	100	1/4" Female Flare S.A.E. Mounting
43375	90	120	1/4" Female Flare, w/18" leads
43354	150	225	1/4" Female Flare S.A.E. Mounting
43355	170	250	1/4" Female Flare S.A.E. Mounting

High Pressure Cut-Out - Open on Pressure Rise

MARS NO.	CUT OUT	CUT IN	NOTES
43337	200	150	1/4" Female Flare S.A.E. Mounting
43321	225	150	1/4" Female Flare S.A.E. Mounting
43322	250	150	1/4" Female Flare S.A.E. Mounting
43324	275	195	1/4" Female Flare S.A.E. Mounting
43325	300	200	1/4" Female Flare S.A.E. Mounting
43326	325	225	1/4" Female Flare S.A.E. Mounting
43320	350	245	1/4" Female Flare S.A.E. Mounting
43327	350	250	1/4" Female Flare S.A.E. Mounting
43328	375	275	1/4" Female Flare S.A.E. Mounting
43329	400	200	1/4" Female Flare S.A.E. Mounting
43330	400	280	1/4" Female Flare S.A.E. Mounting
43331	400	300	1/4" Female Flare S.A.E. Mounting
43311	410	290	1/4" Female Flare S.A.E. Mounting
43332	425	300	1/4" Female Flare S.A.E. Mounting
43333	425	325	1/4" Female Flare S.A.E. Mounting
43334	450	250	1/4" Female Flare S.A.E. Mounting
43365	590	418	1/4" Female Flare w/snubber
43335	600	475	1/4" Female Flare S.A.E. Mounting
43366	610	420	1/4" Copper Clad SS Tube, 90 degree elbow w/snubber
43339	630	480	1/4" Female Flare S.A.E. Mounting
43367	650	450	1/4" Copper Clad SS Tube w/snubber



Fan Cycling - Close on Pressure Rise

MARS NO.	CUT OUT	CUT IN	NOTES
43301	75	100	1/4" Female Flare S.A.E. Mounting
43302	110	170	1/4" Female Flare S.A.E. Mounting
43303	125	265	1/4" Female Flare S.A.E. Mounting
43304	150	225	1/4" Female Flare S.A.E. Mounting
43305	190	275	1/4" Female Flare S.A.E. Mounting
43370	180	240	1/4" Female Flare S.A.E. Mounting
43306	210	275	1/4" Female Flare S.A.E. Mounting
43307	300	400	1/4" Female Flare S.A.E. Mounting



High Pressure - Manual Reset - Open on Pressure Rise

MARS NO.	CUT OUT	CUT IN	NOTES
43312	375	Manual	1/4" Female Flare S.A.E. Mounting
43313	410	Manual	1/4" Female Flare S.A.E. Mounting
43314	415	Manual	Capillary Tube
43315	440	Manual	Capillary Tube
43316	475	Manual	1/4" Female Flare S.A.E. Mounting
43368	590	Manual	1/4" Female Flare w/snubber
43369	610	Manual	1/4" Female Flare w/snubber

Universal Round Silicon Nitride

Cross Reference

Round Silicon Nitride	Robertshaw	Supco	White-Rodgers
68040	41-801N	SSN2000	21D64-2



MARS Hot Surface Igniters

• Includes 3 brackets, wire sleeving, mounting screw, 2 wire nuts, cross reference list, and instruction sheet

• 14" leads

67900
Furnace Igniter Kit

• Replacement for flat and spiral igniters in over 50 furnace applications

• 19" leads with sleeving and connector

67909

REPLACES:
• Coleman 1474-051P, 052P

• 5.5" leads with connector

67914

REPLACES:
• Amana 1004 1601, B1336102, D99182
• Trianco-Heatmaker 2600-359 • Uni-Line 41-401
• White Rodgers 767A-309, 767A-356

• 24" leads with wire nuts

67915

REPLACES:
• Armstrong 38322B001 • Clare C-238, C-242
• DMO 20834, 26789 • Dornback 271W
• Trane 340039P01, IGN23
• Uni-Line 41-238, 41-242, 41-402
• White Rodgers 767A-371 • Williamson 09050

• 5.5" leads with wire nuts

67916

REPLACES:
• Raypak 600915 • Snyder General 1380654 • Trane B138196P01, IGN26, IGN30, Uni-Line 41-403
• Weil McLain 511-330-193

• 9" leads with wire nuts

67917

REPLACES:
• Uni-Line 41-405 • White Rodgers 767A-361 • York 025-27766-000, 025-27774-000, 025-29043-000, 025-29050-000

• 5" leads with connector

67918

REPLACES:
• Trane B144676P02, IGN30 • Uni-Line 41-407

• 5" leads with connector

67919

REPLACES:
• Rheem 62-22868-92, 62-22868-93 • Trane B340039P01 • Uni-Line 41-408

• 5" leads with connector

67920

REPLACES:
• Carrier LH33ZS001, 002, 003, 004 • Ducane 20015201 • Snyder General 1380672, 1380680
• Trane IGN26 • Uni-Line 41-409
• Weil McLain 511-330-139

• 5.5" leads with connector

67923

REPLACES:
• York 025-32625-000

• 5" leads with connector

• Mounting bracket attached

67924

REPLACES:
• Goodman B1401015, B1401018S
• Modine 5H075032B

• 9" leads with wire nuts

• Gasket included

67925

REPLACES:
• Glowcore HSRK-7 • Lochinvar PLT2400
• Surfaceigniter FY009 • Uni-Line 41-406
• Weil-McLain 511-330-188 • White Rodgers 767A-374

• 5" leads with connector

• Bracket included

68013

REPLACES:
• Rheem 62-22868-82 • Uni-Line 41-411

• 5" leads with connector

• Bracket included

68014

REPLACES:
• Goodman B1401009 • Intercity 1009604
• Uni-Line 41-412, 41-414

• 8.5" leads with connector

• Mounting bracket and gasket included

68015

REPLACES:
Rheem 62-22669-92

• 5" leads with connector

68016

REPLACES:
• Trane B144676P01, IGN30 • Uni-Line 41-410

• 5" leads with connector

68017

REPLACES:
• Uni-Line 41-404
• Weil McLain 511-330-190

Flame Sensors

MARS flame sensors are direct OEM replacements. False shutdowns can occur in gas furnaces due to a built up carbon on the flame rod. Incorrect cleaning procedures can also damage the flame rod. Replacing a flame sensor that has triggered a false shutdown is the best preventative maintenance and eliminates nuisance service calls.

Features:

- Direct OEM Replacements
- Improved Service Life
- OEM Mounting Brackets
- Ceramic Insulators

MARS NO.	REPLACES OEM	OEM PART NUMBER
67680	Goodman	10735201
67681	Source 1	SI-02537499000
67682	Source 1	SI-02530788700
67683	Goodman	0130F00010
67684	Allied	44L48
67685	Source 1	SI-02535306000
67686	Source 1	SI-02527773700
67687	Source 1	SI-02535354000
67688	Goodman	B1172601
67689	Source 1	SI-02530802000

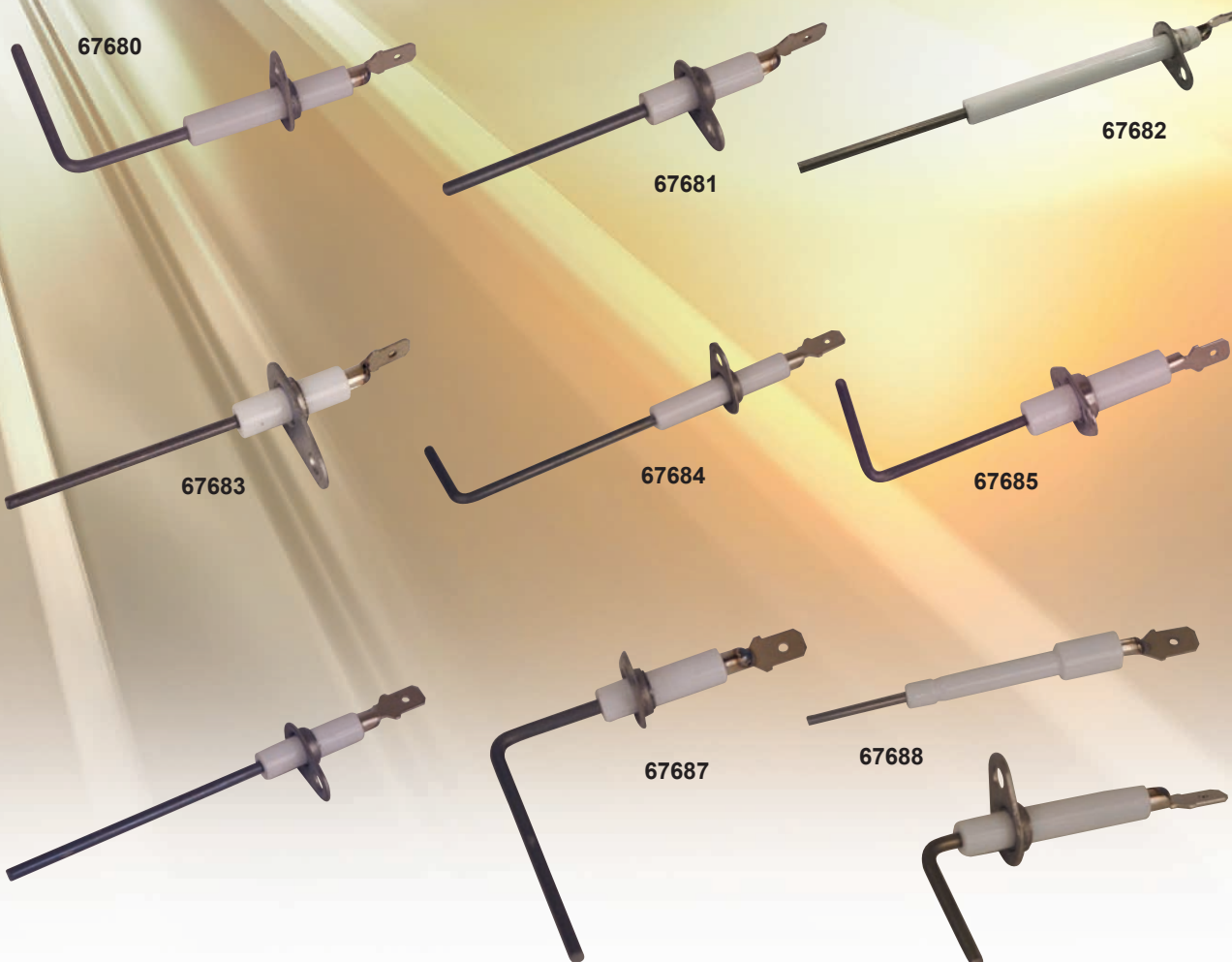

MARS Transformers



Scan for more details.

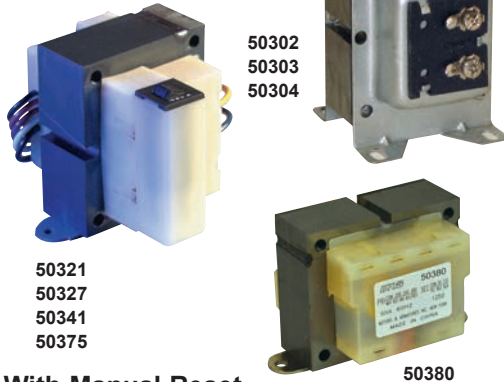

Transformers With Manual Reset

MARS NO.	VOLTAGE PRIMARY	VOLTAGE SECONDARY	VA OUTPUT
50327	120/208/240/480	24	50
50321	120/208/240/480	24	75
50375	208/240/480/575	24	75
50341	120/208/240/480	24	100

Power Transformers

MARS NO.	VOLTAGE PRIMARY	VOLTAGE SECONDARY	VA OUTPUT
50380	208/240/480	120/24	50
50381	208/240/480	120/24	100

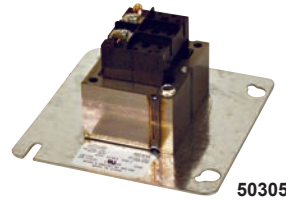

Transformers - End Bell Type

MARS NO.	VOLTAGE PRIMARY	VOLTAGE SECONDARY	VA OUTPUT
50302	120	24	40
50303	208/240	24	40
50304	120/208/240	24	40
50333	120/208/240	24/12/12.5	48
50314	120/208/240	24	50

* Not UL listed (1) Color coded leads on secondary, (2) Screw terminals on secondary

Economy Plate Mount Transformer

MARS NO.	VOLTAGE PRIMARY	VOLTAGE SECONDARY	VA OUTPUT
50305	120	24	40

Frame Mount

MARS NO.	CONNECTION	VOLTAGE PRIMARY	VOLTAGE SECONDARY	VA OUTPUT
50352	wire leads	120	24	40
50353	wire leads	240	24	40
50354	wire leads	120/208/240	24	40
50362	quick conn.	120	24	40
50363	quick conn.	240	24	40

JARD Transformers

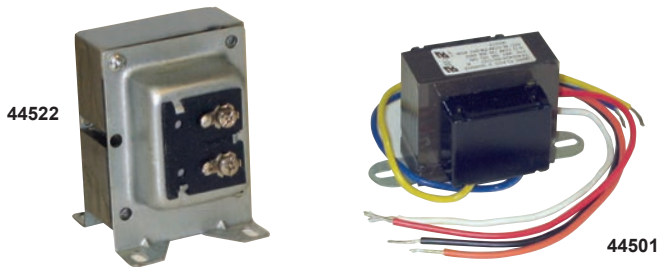

Open Construction, Wire Leads

MARS NO.	JARD NO.	VA	PRIMARY VAC	SECONDARY VAC
44501	2031F	20	120/208/240	24
44502	4011F	40	120	24
44503	4021F	40	208/240	24
44504	4031F	40	120/208/240	24
44505	4032F	40	120/208/240	2.5/12/24
44507	40271F	40	277	24

Closed Construction With Circuit Breaker

MARS NO.	JARD NO.	VA	PRIMARY VAC	SECONDARY VAC
44511	5041C	50	120/208/240/480	24
44512	6041C	60	120/208/240/480	24
44513	7541C	75	120/208/240/480	24
44514	7541STC	75	120/277/380/575	24

Multi-Mount Transformers

Closed Construction, 4" x 4" Plate

MARS NO.	JARD NO.	VA	PRIMARY VAC	SECONDARY VAC
44522	4011M	40	120	24
44524	4031M	40	120/208/240	24
44525	5031M	50	120/208/240	24
44526	5032M	48	120/208/240	2.5/12/24

Adapter Blades Heavy Duty Condenser Fan Blades

MARS 3, 4 & 5 wing adapter, heavy duty condenser fan blades are designed for rigorous R/HVAC pressure applications. They will accommodate universal hex/round adapter hubs for unlimited versatility. MARS adapter fan blades are durable, efficient, and quiet. They are manufactured using high strength aluminum alloy for the blades and sturdy steel for the blade spiders.

Blade depths and pitches specified for MARS adapter fan blades allow for the replacement of a broad range of commonly used fan blades.

Typical applications are:

- Air Cooled Condensers
- Residential Air Conditioners
- Heat Pumps
- Roof Top Air Conditioners
- Power Roof Ventilators
- Unit Heaters
- Fan Coil Units

2-Wing
14" through 24" dia.

3-Wing
10" through 24" dia.

4-Wing
10" through 26" dia.

5-Wing
16" through 30" dia.



Easy
To Read
Labels



Fan Blade & Hub Puller



MARS NO.	DESCRIPTION
40852	Fan Blade & Hub Puller

Fan Blades

MARS NO.	OEM	CROSS REFERENCE
40013	Goodman	Goodman 0150M00008, Goodman 0150M00008S
40011	Goodman	Goodman 0150M00012, Goodman 0150M00012S, Goodman 0150M00009, Goodman 0150M00009S, Nidec US3B2028
40009	Carrier	Carrier LA01RA015, Carrier LA01RA015A, Packard R31811, Nidec US3A1827
40012	Carrier	Carrier LA01RA044, Carrier LA01RA044A, Nidec US3A2223
40010	Carrier	Carrier LA01EC018, Carrier LA01EC018A, Packard R31821, Nidec US3A1834



250 Rabro Drive East
Hauppauge, New York 11788

PRESORT STANDARD
U.S. POSTAGE
PAID
PERMIT #255
HICKSVILLE, NY

**CONTACT
YOUR MARS
REP FOR
MORE
DETAILS**

End Cap Display "Merchandising Program"



Leading The Way with ECM Technology
AZURE by MARS

- Universal Energy Saving ECM
- For HVAC & Commercial Refrigeration
- Reduces Inventory
- Increases Revenue
- Simple Installation

Capacitor Superstore
Choose from Three Complete Lines of North American Manufactured, Time Proven, Brand Recondition Start & Run Capacitors

- MARS Blue Box
- MARS USA
- J&B

Pump It Up!
MARS Condensate Pumps

- 24" LIR
- 20" LIR
- 16" LIR

MARS Motors Replacement Featured Homeowner Models for the HVAC Industry

Strike Back!
With MARS Surge Protectors Help Homeowners Protect Their Equipment

- 4000V Surge Protection Device
- 6000V Surge Protection Device
- 8000V Surge Protection Device
- 10000V Surge Protection Device

10464 MARS
Multi-Horsepower Direct Drive Blower Motor
Motor Ventilador de Transmisi3n Directa con M3ltiples Cabe3as
18, 15, 14, 12, 12 HP 208/230 VAC
4 Speed, 1075 RPM, Rev.

10465 MARS
Multi-HP Condenser Fan Motor
Motor Condensador de Abanico con M3ltiples Cabe3as
18, 15, 14, 1/3 HP, 208/230 VAC
2 Speed, 1075 RPM, Rev.

21788 MARS
Condensate Pump
Bomba De Condensamiento
1/2" LIR

21780 MARS
Condensate Pump
Bomba De Condensamiento
1/2" LIR

MARS
Customer Service:
800.445.4155